

# VF and VL Fan-Coil Units Floor-Mounted, Vertical



# Low Power Consumption, Accessible & Flexible

## VF and VL Fan-Coil Design Features

### Owners

Owners can choose between a standard height (VF) or a low profile (VL) vertical floor-mounted fan coil unit. Both are AHRI certified to ensure exact performance. Either unit utilizes a 3-speed, direct-drive motor to optimize cabinet airflow and sound performance. Enhanced sound levels are achieved through an electronic fan-speed controller (SCR) which allows further motor-speed tuning. Vertical floor mounted concealed model fan-coil units are constructed of galvanized steel. Exposed-cabinet models VFE, VFS and VLE feature durable, powder-coated, galvanealed steel that resists fading, scratches and fingerprints.

Concerned about Indoor Air Quality? Sloped drain pans are standard on all vertical floor mounted units, and are easily removed to provide access to the coils for cleaning. Optional stainless-steel drain pans and coil casings are available. Elastomeric closed-cell-foam insulation is used to promote IAQ.

### Designers

The vertical floor mounted unit's impressive list of standard features provides unparalleled design flexibility. With the variable aspect ratio's the standard cabinet size can be increased in width or height up to 12" (VFE & VFS only). The return-air space on exposed-cabinet models may be fitted with a stamped-louver grille (VFE, or VFS), powder-coat-painted to match the unit. Outside air can be introduced with manual or motorized dampers, or a wall-box assembly (VF only).

Available with chilled-water or DX cooling coils, and hot-water, steam or electric heating coils, vertical floor mounted units produce the ultimate in comfort and flexibility.

### Contractors

Vertical floor mounted fan-coil units provide maximum performance while reducing installed cost to the contractor. Motor wiring is brought to a junction box on the inside of the unit end pocket, reducing electrical hook-up time. Single point power connection is standard on all vertical floor mounted fan-coil units. Motor connections are shipped with quick connectors for ease of replacement. For fast-track jobs, the vertical floor (VF & VL) mounted Quick Ship unit is available in 5, 10 or 15 days with an impressive list of unit options and controls.

### Low Power Consumption

The VF fan coil has raised the bar by lowering the power consumption required. This industry leading power consumption is accomplished with permanent split capacitor (PSC) motors, but can be supplied with an electronically commuted motor. See Airflow and Power Data table.

AIR FLOW & POWER DATA				
Model	Size	Air Flow (SCFM)	Cooling Capacity Total TMBH	Power Consumption at High Speed (Watts)
VF	02	230	5.6	45
	03	320	6.7	60
	04	450	12.1	70
	06	570	16.7	80
	08	630	19.0	114
	10	835	24.9	132
	12	980	26.7	142
VL	02	200	6.5	75
	03	300	9.5	75
	04	400	14.0	75
	06	600	20.0	140

All Cooling performance with 0" ESP, 80 db / 67 wb entering air, 45°F, PSC motors.



TEC3000 COLOR THERMOSTAT

### Factory-Mounted Control Packages

A wide variety of control options and unit mounted thermostats are offered on vertical floor mounted fan-coil units. Factory-mounting and wiring of DDC controls by others is also available. Wireless factory supplied control options can be provided to minimize retrofit costs and provide BAS communication to the front end. Optional thermostats can maximize up to 30% energy savings in high-energy usage light commercial buildings, such as schools and hotels during occupied times by using additional standby set-points.

### Factory-Furnished Valve Packages

Valve packages provided by the factory ensure proper fit, operation and performance. Factory supplied actuators are shipped with quick connects to allow fast and accurate connection.

Optional factory installed piping packages arrive at the job site installed, tested and ready for startup.



## VFE, VFS, VFC Accessibility Features



### End Pockets

The 8" end pockets allow for accessibility and service of optional factory piping packages and controls. End panels are removable to allow for even greater access.



### Fan Deck

The fan/drain pan assembly is easily removable for service access to motors and blowers at, or away from, the unit.

### Drain Pan

The sloped insulated primary drain pan is available in stainless steel construction. The standard drain pan is externally insulated, single wall galvanized steel. The VF series fan/drain-pan assembly is easily removable for cleaning.



### Coils

All units are available in 2 or 4 pipe configurations. The heating coil is standard in the reheat position. Heating and cooling coils are available with same or opposite end (VF only) connections. Access for cleaning on the entering air side is available when the drain pan is removed. Coils are removable for service.



### Filter

The filter is easily replaceable through the return air toe space without requiring removal of the front panel.

### Powder Coated Painted Surface

Exposed cabinet models VFE and VFS, as well as supply and return air grilles and the VFC wall recessing panel, feature a powder coat finish that resists scuffing, scratching, fading, and fingerprints.





## VFE, VFS, VFC Construction Features



### Lid Removal

Top panel is removable from fan coil without the need to disconnect piping or electrical wires.



### Control Enclosure

The VF control enclosure provides adequate space for the unit controller and fan coil relay. The fan coil relay is designed to limit diagnostic problems, while allowing for multi-voltage fan power input. The board is designed for factory installed, color coded, plug and play connections designed to ensure accurate wiring.

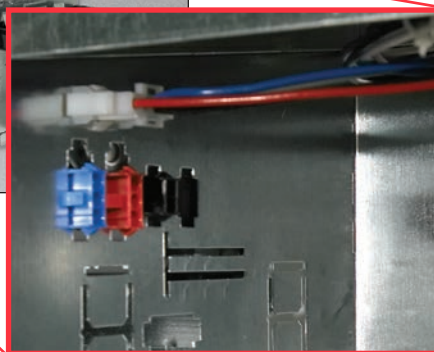
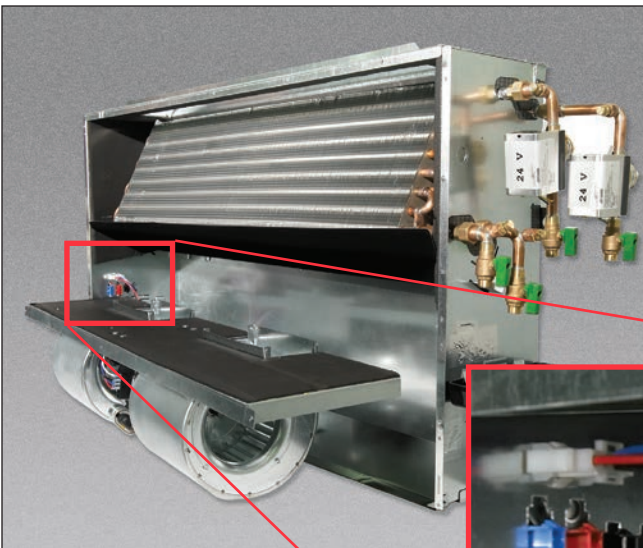

### Fan Deck Removal

VF units allow for a single technician to service the fan/motor by keeping the fan deck to less than 44". Motors are supplied with quick connectors to allow electric service without the need for tools.

## Piping Packages Factory Installed

Factory installed piping packages come equipped with components specific to the project. Actuators ship with color coded plug and play connections for quick, accurate installations.

Factory installed valve packs can ship factory installed on the unit, reducing job site labor and project time.

Factory installed valve packs ship wired, and tested.

Valve packs come standard with unions and manual ball valves which can be used to separate the coil from the water loop allowing the coil to be serviced or replaced without the need to cut or braze the piping.



## Retrofitting Made Easy

### Parametrically Designed Cabinets

VFE (Exposed) and VFS (Sloped) are designed to accommodate existing architectural features. Parametric cabinets permit extending the cabinet heights and widths in 1" increments up to 12", such as when additional height is needed to reach a window sill without the use of a sub-base. Thanks to parametric cabinet design, unattractive sub-bases are no longer required. Parametric designed cabinet will enable the extension of end pockets. Parametric cabinets give designers a greater degree of flexibility.

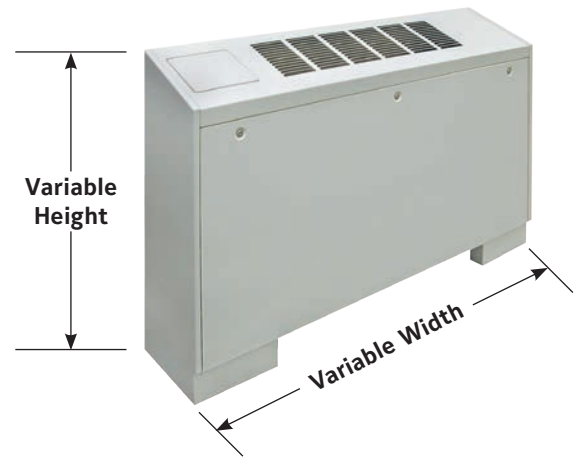

## VL Series Construction Features



### Fan Deck

The fan/drain pan assembly is easily removable for service access to motors and blowers at, or away from, the unit.

### Drain Pan

The sloped insulated primary drain pan is available in stainless steel construction. The standard drain pan is externally insulated, single wall galvanized steel. A non-metallic auxiliary drip pan is provided as standard. The VL Series fan/drain pan assembly is easily removable for cleaning.

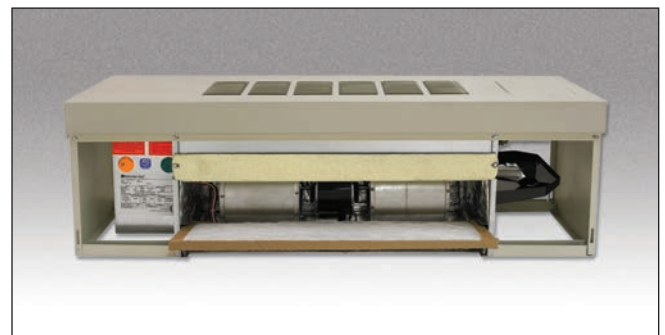

### Filter

The filter is easily replaceable through the return air loop space without requiring removal of the front panel.

# Concealed, Exposed or Parametric Cabinet Options

**Model VFC Concealed Dimensional Data**

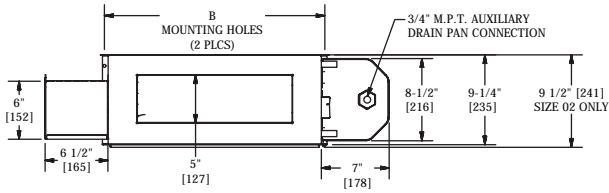

**TOP VIEW**

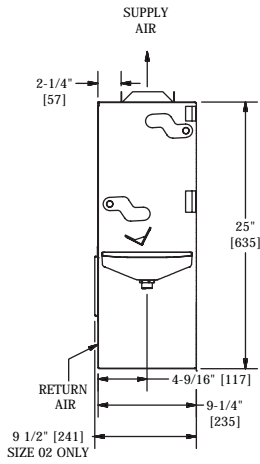

**SIDE VIEW**

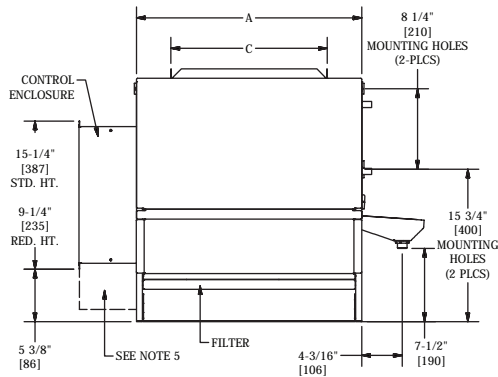

**FRONT VIEW**

Unit Size	Dimensions		
	A	B	C
02	23 3/16" [589]	22 3/4 [578]	16" [406]
03	27 3/16 [691]	26 3/4 [679]	20" [508]
04	33 3/16 [843]	32 3/4 [832]	26" [660]
06	43 3/16 [1097]	42 3/4 [1086]	36" [914]
08	45 3/16 [1148]	44 3/4 [1137]	38" [965]
10	59 3/16 [1503]	58 3/4 [1492]	52" [1320]
12	67 3/16 [1707]	66 3/4 [1695]	60" [1524]

**Model VFE Parametric Increments**

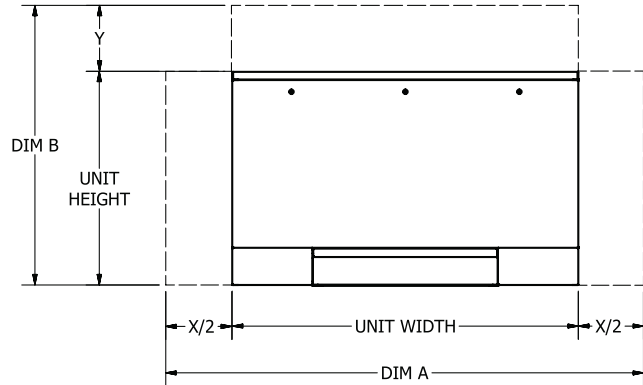

**Model VFS Parametric Increments**

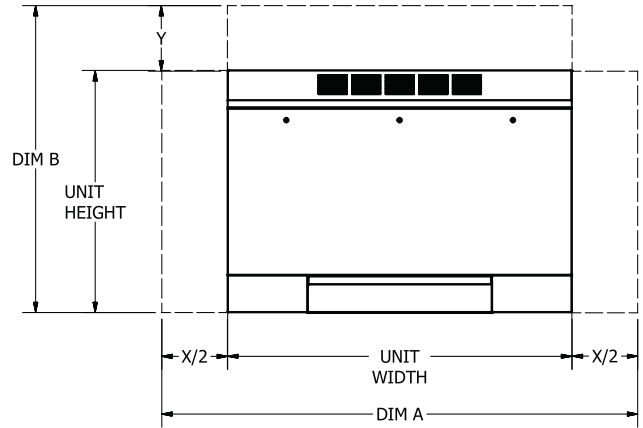

		DIMENSION A (inches)												
SIZE		X=0	X=1	X=2	X=3	X=4	X=5	X=6	X=7	X=8	X=9	X=10	X=11	X=12
VFE & VFS	02	41	42	43	44	45	46	47	48	49	50	51	52	53
	03	45	46	47	48	49	50	51	52	53	54	55	56	57
	04	51	52	53	54	55	56	57	58	59	60	61	62	63
	06	61	62	63	64	65	66	67	68	69	70	71	72	73
	08	63	64	65	66	67	68	69	70	71	72	73	74	75
	10	77	78	79	80	81	82	83	84	85	86	87	88	89
	12	85	86	87	88	89	90	91	92	93	94	95	N/A	N/A
		DIMENSION B (inches)												
ALL SIZES		Y=0	Y=1	Y=2	Y=3	Y=4	Y=5	Y=6	Y=7	Y=8	Y=9	Y=10	Y=11	Y=12
		28 3/4	29 3/4	30 3/4	31 3/4	32 3/4	33 3/4	34 3/4	35 3/4	36 3/4	37 3/4	38 3/4	39 3/4	40 3/4

		DIMENSION A (millimeters)														
SIZE		X=0	X=25	X=51	X=76	X=102	X=127	X=152	X=178	X=203	X=229	X=254	X=279	X=305		
VFE & VFS	02	1041	1067	1092	1118	1143	1168	1194	1219	1245	1270	1295	1321	1346		
	03	1143	1168	1194	1219	1245	1270	1295	1321	1346	1372	1397	1422	1448		
	04	1295	1321	1346	1372	1397	1422	1448	1473	1499	1524	1549	1575	1600		
	06	1549	1575	1600	1626	1651	1676	1702	1727	1753	1778	1803	1829	1854		
	08	1600	1626	1651	1676	1702	1727	1753	1778	1803	1829	1854	1880	1905		
	10	1956	1981	2007	2032	2057	2083	2108	2134	2159	2184	2210	2235	2261		
	12	2159	2184	2210	2235	2261	2286	2311	2337	2362	2388	2413	N/A	N/A		
		DIMENSION B (millimeters)														
ALL SIZES		Y=0	Y=25	Y=51	Y=76	Y=102	Y=127	Y=152	Y=178	Y=203	Y=229	Y=254	Y=279	Y=305		
		730	756	781	806	832	857	883	908	933	959	984	1010	1035		

**NOTES:**

- All dimensions in inches [mm]. All dimensions ± 1/4" [6mm]. Metric values are soft conversion.
- Junction box size and location varies with unit features. Control options may be limited. Provide sufficient clearance to access electrical controls and comply with applicable codes and ordinances.
- Right-hand unit shown, left-hand unit similar, but opposite.
- Auxiliary drain pan ships loose for field installation.
- Standard VFE and VFS cabinet finish is "Pearl White Satin".

**NOTES:**

Internal chassis and air openings remain the same. External cabinet can increase in height and width in 1" (25.4mm) increments up to 12" (305mm).

**NOTE:** All data and dimensions are subject to change without notice.

Ask your representative for current submittal drawings and other unit arrangements, including Model VFS Sloped Top.

# Concealed, Exposed or Parametric Cabinet Options

## Model VLC Concealed Dimensional Data

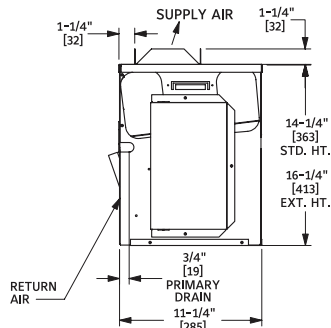
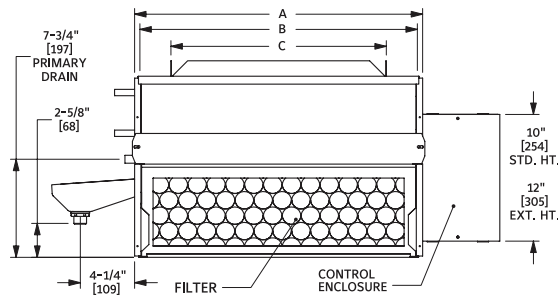
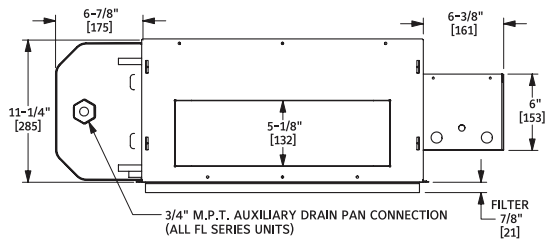

## Model VLE Exposed Cabinet Dimensional Data

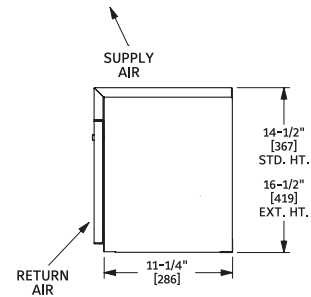
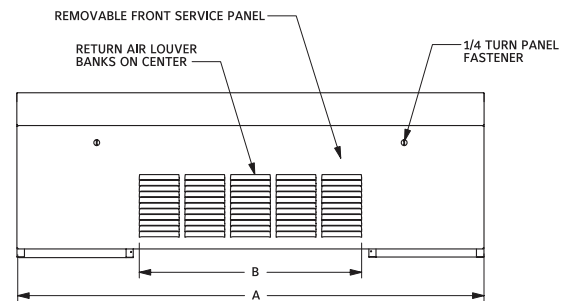
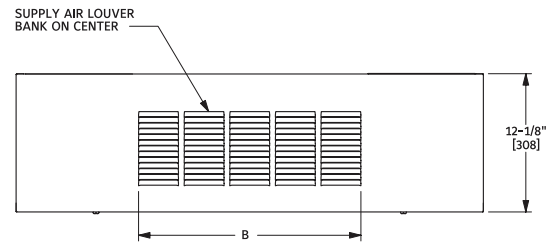

Unit Model	Dimension		
	A	B	C
02	23" [584]	22" [559]	17" [432]
03	28" [711]	27" [686]	22" [559]
04	36" [914]	35" [889]	30" [762]
06	50" [1270]	49" [1245]	44" [1118]

### NOTES:

- All dimensions are inches [mm] and are  $\pm 1/4"$  [6mm]. Metric values are soft conversion.
- Junction box size and location varies with unit features. Control options may be limited. Provide sufficient clearance to access electrical controls and comply with applicable codes and ordinances.
- Left hand unit shown; right hand unit similar but opposite.
- Auxiliary drain pan ships loose for field installation.

Unit Model	Dimension	
	A	B
02	41" [1041]	19-1/2" [495]
03	46" [1168]	23-1/2" [597]
04	54" [1372]	31-1/2" [800]
06	68" [1127]	43-1/2" [1105]

### NOTES:

- All dimensions are inches [mm] and are  $\pm 1/4"$  [6mm]. Metric values are soft conversion.
- Junction box size and location varies with unit features. Control options may be limited. Provide sufficient clearance to access electrical controls and comply with applicable codes and ordinances.
- Left hand unit shown; right hand unit similar but opposite.
- Standard cabinet finish is Pearl White Satin.

# Standard & Optional Features

## STANDARD FEATURES:

### Construction

#### All Units

- AHRI Standard 440 certified and labeled
- Galvanized steel construction
- Insulation, VF: elastomeric closed cell foam
- Insulation, VL: 1/2" thick fiberglass insulation
- Integral filter rack with 1" throwaway filter

#### Concealed Units

- Top supply with duct collar

#### Exposed Units

- Top stamped louver supply grille
- Durable powder coat paint
- End pockets with removable panels
- 18 gauge exterior panel construction
- Flat top
- Sloped top (VF only)

#### Coils

- Cooling – 3 or 4 row chilled water or DX, heat pump compatible
- Heating – 1 or 2 row hot water or steam – reheat position
- 3/8" O.D. seamless copper tubes
- 0.012" tube wall thickness
- High efficiency aluminum fin surface for optimizing heat transfer, pressure drop and carryover
- Left or right hand, same or opposite (VF only) end connections
- Removable for service
- Manual air vents

### Drain Pans

- Single wall, galvanized steel, externally insulated
- Double sloped to drain connection
- 3/4" M.P.T. auxiliary drain pan connection
- Double wall plastic auxiliary drip pan

### Fan Assemblies

- Forward curved, DWDI centrifugal type
- 115V, 277V, single phase, 3-speed PSC motors
- Quick disconnect motor connections
- Removable for service

### Electrical

- cETL listed for safety compliance
- Electrical junction box for field wiring terminations
- Terminal block for field connections

### Electric Heat

- Finned tubular element on all floor mounted units protects against electrical shock
- ETL listed as an assembly for safety compliance
- Integral electric heat assembly with removable elements for easy service
- Automatic reset primary and back-up secondary thermal limits
- Single point power connection

## OPTIONAL FEATURES:

### Construction

#### All Units

- Foil faced fiberglass insulation (VL)
- Elastomeric closed cell foam insulation (VL)
- Manual and motorized outside air dampers
- Spare 1" throwaway filters
- 1" pleated filters (MERV 7)
- Wall boxes (VF only)
- Leveling legs

#### Concealed Units

- Wall recessing panels (VF only)

#### Exposed Units

- Linear bar discharge grille, powder coated
- 16 gauge front panel (VF only)
- Return air louver grille
- 2" – 8" falsebacks (VF only)
- Extended end pockets (VF only)
- Tamper proof fasteners

### Coils

- Automatic air vents
- Stainless steel coil casings
- 1/2" O.D. seamless copper tubes
- 0.016" tube wall thickness
- 0.025" tube wall

### Drain Pans

- Stainless steel construction with external insulation
- Double wall plastic auxiliary drain pan -- extended length (VF only)
- Stainless steel auxiliary drain pan -- extended length (VF only)

### Fan Assemblies

- 115V, 208–230V, 277V, single phase, 3-speed fixed, 3-speed adjustable, or 2-10VDC proportional ECM motors (VF only)

### Electrical

- SCR fan speed controller (high speed only)
- Fan relay packages
- Silent solid state fan relays (VF only)
- Toggle disconnect switch
- Condensate overflow switch (on auxiliary drain pan)
- Main fusing
- Unit and remote mounted 3-speed fan switches

### Electric Heat

- Door interlocking disconnect switches
- Main fusing
- Silent relay/contactors (VF only)

### Piping Packages

- Factory assembled: shipped loose for field installation, or factory-installed option available
- 1/2" and 3/4", 2-way and 3-way normally closed, two position electric motorized valves
- Isolation ball valves with memory stop
- 4 pipe with 3-way valve (VF only)
- Fixed and adjustable flow control devices
- Unions and P/T ports
- Modulating control valves
- High pressure close-off actuators (1/2" = 50 PSIG; 3/4" = 25 PSIG)

### Thermostats

- Digital display, programmable or non-programmable
- Unit and remote mounted, with integral 3-speed fan switch
- 2-pipe and 4-pipe control sequences
- Automatic and manual changeover