

CATALOG

# CRC Series Flow, Fan-Powered, Sensible Cooling VAV Terminals



# TABLE OF CONTENTS

Features And Benefits .....	3
Construction Features .....	5
Standard And Optional Features .....	7
Application And Selection .....	9
Primary Airflow Calibration .....	12
Unit Arrangements.....	13
Dimensional Data .....	15
CRC Cooling Only .....	15
CRC Cooling Only / 90 Degree Enclosure.....	16
CRC With Hot Water Coil.....	17
CRC With Hot Water Coil / 90 Degree Enclosure.....	18
CRC With Electric Heat.....	19
CRC With Electric Heat / 90 Degree Control Enclosure .....	20
Sound Power Data .....	21
EC Fan Motor .....	23
General Selection, EC Motor .....	24
Fan And Motor Data .....	25
Fan Performance, EC Motor .....	26
Electric Heat .....	27
Sensible Cooling Coil Data .....	28
Hot Water Coil Data .....	41
Coil Face Area, Free Area, Filter Sizes.....	48
Guide Specifications.....	49

NOTES:

- All data herein is subject to change without notice. Some drawings are not shown in this catalog.
- Drawings not for installation purposes.
- Construction drawings and performance data contained herein should not be used for submittal purposes.
- ETL Report Number 476203.



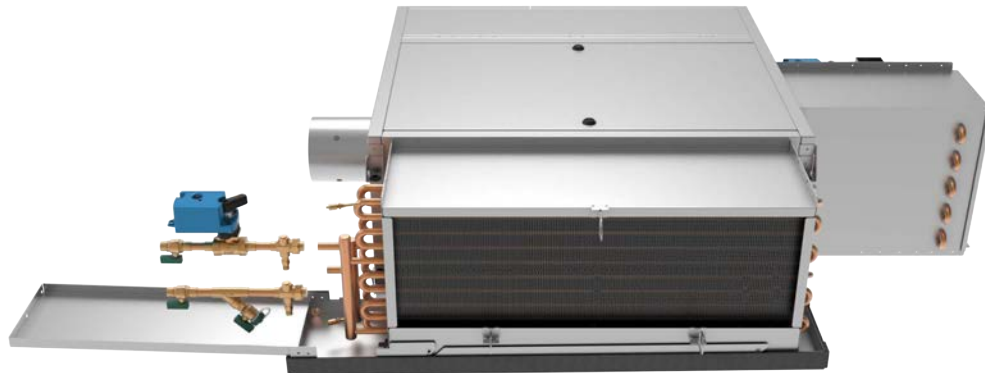

## FEATURES AND BENEFITS

### QUIET, EFFICIENT COMFORT

Model CRC fan terminals are specifically designed for quiet operation. They also offer improved space comfort and flexibility for a wide variety of HVAC systems. This is critical in today's buildings, where occupants are placing more emphasis on indoor acoustics.

### OCCUPANT-SENSITIVE DESIGN

Due to heightened interest in Indoor Air Quality, many HVAC system designers are focusing on the effects of particulate contamination within a building's occupied space. Often, HVAC system noise is overlooked as a source of occupied space contamination. The CRC terminal is specifically designed to eliminate obtrusive fan noise from reaching the occupants, while providing constant air motion in the space.

Occupants will benefit from the CRC design that minimizes sound levels that typically dominate the space sound level. The CRC also minimizes the fluctuation in sound levels that occur during VAV damper modulation.

### FLEXIBILITY

**Selection and Layout** The CRC provides flexibility in system design. Reduced noise at the fan terminal allows the system designer to place properly sized units directly above occupied spaces. It is not necessary to use the crowded space above a hall or corridor to locate

the equipment. This will reduce lengthy and expensive discharge duct runs. The standard shallow casing height (15" up to 1400 CFM) minimizes conflict with other systems competing for ceiling space. The FlowStar™ sensor ensures accurate control, even when space constraints do not permit long straight inlet duct runs to the terminal.

**Sizes** Model CRC terminals are available in six unit sizes to handle airflow capacities between 100 and 2000 CFM. Most fan sizes are available with multiple primary air valve sizes to optimize the unit fan and primary air valve combinations required by current industry needs.

Web-based selection program, Web-Select, is the preferred method for selecting product. Contact your representative to obtain access to this powerful and time-saving program.

### CONVENIENCE

**Quality** All CRC terminals are thoroughly inspected during each step of the manufacturing process, including a comprehensive pre-ship inspection, to assure the highest quality product available. Each unit is also run tested before leaving the factory to ensure trouble free field start-up.

**Quick Installation** A standard single point electrical main power connection is provided. Electronic controls and electrical components are located on the same side

## FEATURES AND BENEFITS

---

of the casing for quick access, adjustment, and troubleshooting. Installation time is minimized with the availability of factory calibrated controls.

CRC terminals utilize EC motors that accommodate a broad range of flow and static pressure field conditions while dramatically increasing efficiency.

The FlowStar™ sensor ensures accurate airflow measurement, regardless of the field installation conditions. A calibration label and wiring diagram is located on the terminal for quick reference during start-up.

The terminal is constructed with integrated vibration isolating hanger brackets, for use with all-thread support rods or wire hangers.

### VALUE AND SECURITY

**Quality** All metal components are fabricated from galvanized steel. Unlike most manufacturers' terminals, the steel used in the CRC is capable of withstanding a 125 hour salt spray test without showing any evidence of red rust.

**Energy Efficiency** In addition to quiet and accurate temperature control, the building owner will benefit from lower operating costs. The highly amplified velocity pressure signal from the FlowStar™ inlet sensor allows precise airflow control at low air velocities.

The FlowStar™ sensor's airfoil shape provides minimal pressure drop across the terminal. This allows the central fan to run at a lower pressure and with less brake horsepower. Energy efficient fan motors are manufactured to ensure efficient, quiet, reliable, and low maintenance operation.

Single and three phase EC motors provide efficient, quiet, reliable, and low maintenance operation. However, different installations may have different operational priorities.

EC motors in CRC terminals provide a choice of pressure independent airflow or energy saving airflow. Either of these operating modes can be controlled with a single speed adjustable interface, or a 0-10VDC proportional interface.

The unique combination of motors, fans, and cabinets available for the CRC terminal provide market leading airflow, acoustic, and energy performance while allowing any of these parameters to be prioritized for even greater performance.

**Agency Certification** Model CRC terminals, including those with electric heat, are listed with ETL as an assembly, and bear the ETL label. CRC terminals comply with applicable NEC requirements, and are tested in accordance with AHRI Standard 880.

**Maintenance and Service** CRC fan terminals require no periodic maintenance other than optional filter replacement. If component replacement becomes necessary, the unit is designed to minimize field labor. The top and bottom casing panels can be removed to provide easy access to the fan assembly, and the motor electrical leads are easily unplugged.

**Controls** Model CRC terminals are available with consignment controls.

Standard features include the patented FlowStar™ airflow sensor, ETL Listing, NEMA 1 enclosure, 24VAC control transformer, floating modulating actuator, balancing tees and plenum rated tubing.

## CONSTRUCTION FEATURES

### MODEL CRC

The CRC terminal incorporates many unique features. Many of these **standard** features are expensive options for other manufacturers.

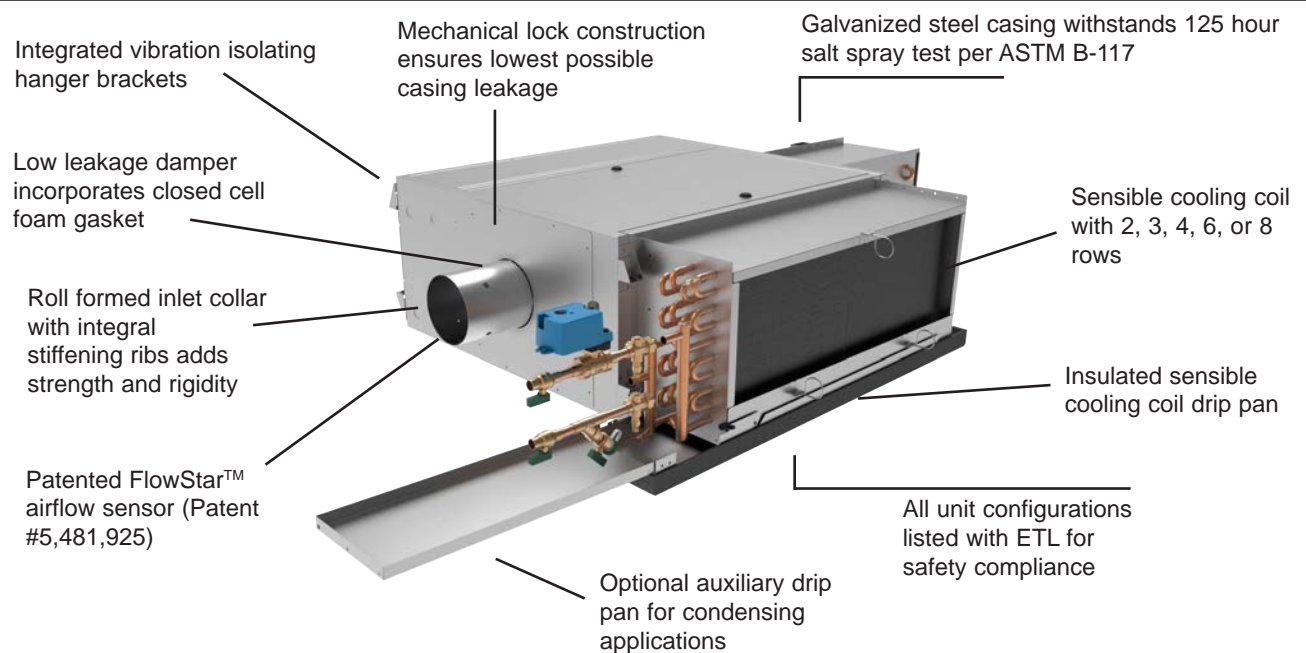
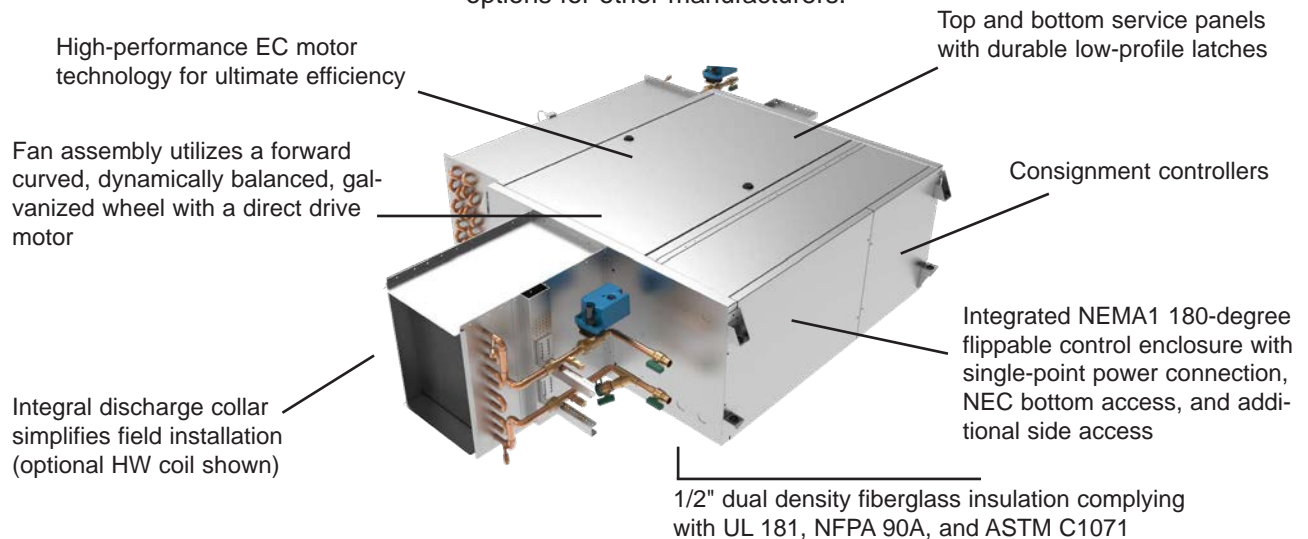

### OPTIONAL CONSTRUCTION FEATURES

- 1" double wall construction.
- Scrim reinforced foil faced insulation meeting ASTM C1136 for mold, mildew, and humidity resistance.
- 1/2" or 1" elastomeric closed cell foam, fiberglass, or foil-faced fiberglass insulation.
- 1" or 2" throwaway or pleated filter located at induction inlet. MERV8, MERV13 option available.
- Hot water (CRC-WC) or electric heating coils (CRC-EH) mounted at unit discharge. Access plate upstream of hydronic coil is standard.
- Factory control options: Consignment DDC Controls.
- Factory-provided and factory-installed piping packages.
- Insulated drain pan with available auxiliary drain for condensing applications.

# CONSTRUCTION FEATURES

## ACCURATE AND ENERGY-SAVING AIRFLOW CONTROL WITH THE PATENTED FLOWSTAR™ SENSOR

Many VAV terminals waste energy due to an inferior airflow sensor design that requires the minimum CFM setpoint to be much higher than the IAQ calculation requirement. This is common with interior spaces that will be affected year round. These interior VAV terminals waste energy in several ways. First, the primary air fan (e.g. AHU) supplies more CFM than the building requires. The higher minimum CFM setpoint overcools the zone with VAV terminals without integral heat. To maintain thermal comfort a building engineer would need to change the minimum setpoint to zero CFM compromising indoor air quality. Interior VAV terminals with integral heat provide adequate comfort in the space but waste significant energy as energy is consumed to mechanically cool the primary air only to have more energy consumed to heat the cooled primary air. Significant energy savings is obtained with proper sizing and by making sure approved VAV terminals are capable of controlling at low CFM setpoints, providing the minimum ventilation requirement.

Currently, most DDC controllers have a minimum differential pressure limitation between 0.015" and 0.05" w.g. The major DDC manufacturers can control down to 0.015" w.g. An airflow sensor that does not amplify, e.g., a Pitot tube, requires about 490 FPM to develop 0.015" w.g. differential pressure. The FlowStar™ develops 0.015" w.g. pressure with only 290 FPM on a size 6 terminal. Consequently, VAV terminals utilizing a non-amplifying type sensor could have minimum CFM's that are well over 50% higher than an ENVIRO-TEC terminal. Many airflow sensors provide some degree of amplification simply due to the decrease in free area of the inlet from large area of the sensor. These VAV terminals still require minimum CFM's up to 30% higher than an ENVIRO-TEC terminal, have higher sound levels, and higher pressure drop requiring additional energy consumption at the primary air fan.

A VAV system designed with ENVIRO-TEC terminals consumes significantly less energy than a comparable system with competitor's terminals. The FlowStar™

airflow sensor reduces energy consumption by allowing lower zone minimum CFM setpoints, greatly reducing or eliminating "reheat", and by imposing less resistance on the primary air fan.

The ENVIRO-TEC air valve features the FlowStar™ airflow sensor which has brought new meaning to airflow control accuracy. The multi-axis design utilizes between 12 and 20 sensing points that sample total pressure at center points within equal concentric cross-sectional areas, effectively traversing the air stream in two planes. Each distinct pressure reading is averaged within the center chamber before exiting the sensor to the controlling device.

This sensor adds a new dimension to signal amplification. Most differential pressure sensors provide a signal between .5 and 2 times the equivalent velocity pressure signal. The FlowStar™ provides a differential pressure signal that is 2.5 to 3 times the equivalent velocity pressure signal. This amplified signal allows more accurate and stable airflow control at low airflow capacities. Low airflow control is critical for indoor air quality, reheat minimization, and preventing over cooling during light loads.

Unlike other sensors which use a large probe surface area to achieve signal amplification, the FlowStar™ utilizes an unprecedented streamline design which generates amplified signals unrivaled in the industry. The streamlined design also generates less pressure drop and noise.

The VAV schedule should specify the minimum and maximum airflow setpoints, maximum sound power levels, and maximum air pressure loss for each terminal. The specification for the VAV terminal must detail the required performance of the airflow sensor. For maximum building occupant satisfaction, the VAV system designer should specify the airflow sensor as suggested in the Guide Specifications of this catalog.

FlowStar™ Airflow Sensor Patent #5,481,925

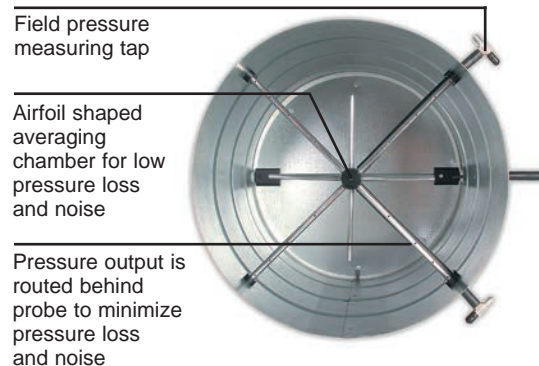
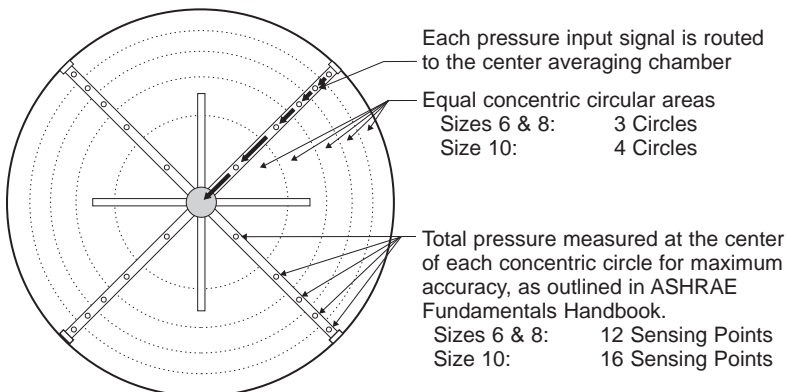

# STANDARD AND OPTIONAL FEATURES

---

## STANDARD FEATURES

### Construction

- Tested in accordance with AHRI 880
- 20 gauge galvanized steel casing and valve
- 1/2" dual density fiberglass insulation
- Full metal nosing for 1/2" and 1" insulation
- Top and bottom access panels with durable latches
- Removable motor/blower assembly
- Integrated hanger brackets with vibration isolating grommets

### Fan Assembly

- Forward curved, dynamically balanced, direct drive, galvanized fan wheel
- 120, 208-230, and 277 volt single-phase EC motors
- Solo or Sync motor control technology
- Constant Torque or Constant Airflow operation
- Permanently lubricated motor bearings
- Thermally protected motor
- Vibration isolation motor mounts
- Single point wiring

### Primary Air Valve

- Embossed rigidity rings
- Low thermal conductance damper shaft
- Position indicator on end of damper shaft
- Mechanical stops for open and closed position
- FlowStar™ center averaging airflow sensor
- Balancing tees
- Plenum rated sensor tubing

### Sensible Cooling Coils

- Coils are designed, manufactured, and tested by ENVIRO-TEC
- AHRI 410 certified and labeled
- 2, 3, 4, 6, and 8 row coils with 5/8" headers
- 3/8" and 1/2" tube options
- Tested at a minimum of 450 PSIG under water and rated at 450 PSIG working pressure at 200°F
- Left or right hand connections

### Drip Pans

- Single wall, galvanized steel, externally insulated with 1/8" closed cell foam
- Tool-free removal

### Electrical

- cETL listed for safety compliance
- Flippable integrated electrical controls enclosure with NEC bottom access and additional side access
- NEMA 1 certified enclosure

### Electric Heat

- ETL listed as an assembly for safety compliance per UL 1995
- Removable electric heat assembly
- Automatic reset primary and back-up secondary thermal limits
- Single point power connection
- Fusing per NEC

## STANDARD AND OPTIONAL FEATURES

---

### OPTIONAL FEATURES

#### Construction

- 1/2" foil-faced fiberglass or closed cell foam insulation
- 1" dual density fiberglass, foil-faced fiberglass, or closed-cell foam insulation
- 1" double wall construction with 20 gauge liner
- 1" and 2" throwaway or pleated filters
- 1" and 2" tool-free filter clips
- 90-degree flippable control enclosure, NEMA 1 certified

#### Fan Assembly

- 480 volt three-phase EC motor

#### Electrical

- Full unit disconnect switch
- Inline motor fusing
- Primary and secondary transformer fusing
- Moisture sensor or float switch

#### Hot Water Coils

- Coils are designed, manufactured, and tested by ENVIRO-TEC
- AHRI 410 certified and labeled
- 1, 2, 3, 4 row coils with 5/8" headers
- 3/8" and 1/2" tube options
- Tested at a minimum of 450 PSIG under water and rated at 450 PSIG working pressure at 200°F
- Left or right hand connections

#### Drain Pans (For Condensing Applications)

- Single wall, galvanized steel, externally insulated with 1/8" closed cell foam
- Double-sloped to 7/8" drain connection
- Available with auxiliary drain connection
- Tool-free removal

#### Electric Heat

- Staged or Proportional with SSR
- Fused or non-fused door interlocking disconnect switches

#### Piping Packages

- Factory-provided and factory-mounted
- 1/2" 2-way and 3-way, normally closed, two position electric motorized valves
- 24VAC floating point modulating control valves
- 0-10VDC proportional control valves
- Isolation ball valves with memory stop
- Fixed (FC) and adjustable (PICV) flow control devices
- Y-Strainers, P/T ports, 18" flexible hose

#### Controls

- Consignment controllers (factory mount and wire controls provided by others)



## APPLICATION AND SELECTION

---

### PURPOSE OF SERIES FLOW FAN TERMINALS

Series flow fan powered terminals offer improved space comfort and flexibility in a wide variety of applications. Substantial operating savings can be realized through the recovery of waste heat, reduced central fan horsepower requirements and night setback operation.

**Heat Recovery** The CRC recovers heat from lights and core areas to offset heating loads in perimeter zones. Additional heat is available at the terminal unit using electric or hot water heating coils. Controls are available to energize remote heating devices such as wall fin, fan coils, radiant panels, and roof load plenum unit heaters.

**IAQ** The CRC enhances the indoor air quality of a building by providing constant air motion, and higher air volumes in the heating mode than typically provided by straight VAV single duct terminals or parallel flow fan terminals. The higher air capacity provides continuous air motion in the space and lowers the heating discharge air temperature. This combination improves air circulation, preventing accumulation of CO<sub>2</sub> concentrations in stagnant areas. Increased air motion improves occupant comfort. The higher air capacity also improves the performance of diffusers and minimizes diffuser “dumping”.

### ACOUSTICAL CONCEPTS

The focus on indoor air quality is also having an effect on proper selection of air terminal equipment with respect to acoustics.

**Sound** At the zone level, the terminal unit generates acoustical energy that can enter the zone along two primary paths. First, sound from the unit fan can propagate through the downstream duct and diffusers before entering the zone (referred to as Discharge or Airborne Sound). Acoustical energy is also radiated from the terminal casing and travels through the ceiling cavity and ceiling system before entering the zone (referred to as Radiated Sound).

To properly quantify the amount of acoustical energy emanating from a terminal unit at a specific operating condition (i.e. CFM and static pressure), manufacturers must measure and publish sound power levels.

The units of measurement, decibels, actually represent units of power (watts). The terminal equipment sound power ratings provide a consistent measure of the generated sound independent of the environment in which the unit is installed. This allows a straight forward comparison of sound performance between equipment manufacturers and unit models.

**Noise Criteria (NC)** The bottom line acoustical criteria for most projects is the NC (Noise Criteria) level. This NC level is derived from resulting sound pressure levels in the zone. These sound pressure levels are the effect of acoustical energy (sound *power* levels) entering the zone caused by the terminal unit and other sound generating sources (central fan system, office equipment, outdoor environment, etc.).

The units of measurement is once again decibels; however, in this case decibels represent units of pressure (Pascals), since the human ear and microphones react to pressure variations.

There is no direct relationship between sound power levels and sound pressure levels. Therefore, we must predict the resulting sound pressure levels (NC levels) in the zone based in part by the published sound power levels of the terminal equipment. The NC levels are totally dependent on the project specific design, architecturally and mechanically. For a constant operating condition (fixed sound power levels), the resulting NC level in the zone will vary from one project to another.

**AHRI 885** A useful tool to aid in predicting space sound pressure levels is an application standard referred to as AHRI Standard 885. This standard provides information (tables, formulas, etc.) required to calculate the attenuation of the ductwork, ceiling cavity, ceiling system, and conditioned space below a terminal unit. These attenuation values are referred to as the “transfer function” since they are used to transfer from the manufacturer’s sound power levels to the estimated sound pressure levels resulting in the space below, and/or served by the terminal unit. The standard does not provide all of the necessary information to accommodate every conceivable design; however, it does provide enough information to approximate the transfer function for most applications. Furthermore, an Appendix is provided that contains typical attenuation values. Some manufacturers utilize different assumptions with respect to a “typical” project design; therefore, cataloged NC levels should not be used to compare acoustical performance. Only certified sound power levels should be used for this purpose.

### GENERAL DESIGN RECOMMENDATIONS FOR A QUIET SYSTEM

**The AHU** Sound levels in the zone are frequently impacted by central fan discharge noise that either breaks out (radiates) from the ductwork or travels through the distribution ductwork and enters the zone as airborne (discharge) sound. Achieving acceptable sound levels in the zone begins with a properly designed central fan system which delivers relatively quiet air to each zone.

## APPLICATION AND SELECTION

**Supply Duct Pressure** One primary factor contributing to noisy systems is high static pressure in the primary air duct. This condition causes higher sound levels from the central fan and also higher sound levels from the terminal unit, as the primary air valve closes to reduce the pressure. This condition is compounded when flexible duct is utilized at the terminal inlet, which allows the central fan noise and air valve noise to break out into the ceiling cavity and then enter the zone located below the terminal. Ideally, the system static pressure should be reduced to the point where the terminal unit installed on the duct run associated with the highest pressure drop has the minimum required inlet pressure to deliver the design airflow to the zone. Many of today's HVAC systems experience 0.5" w.g. pressure drop or less in the main trunk. For systems that will have substantially higher pressure variances from one zone to another, special attention should be paid to the proper selection of air terminal equipment.

To date, the most common approach has been to select (size) all of the terminals based on the worst case (highest inlet static pressure) condition. Typically, this results in 80% (or higher) of the terminal units being oversized for their application. This in turn results in much higher equipment costs, but more importantly, drastically reduced operating efficiency of each unit. This consequently decreases the ability to provide comfort control in the zone. In addition, the oversized terminals cannot adequately control the minimum ventilation capacity required in the heating mode.

A more prudent approach is to utilize a pressure reducing device upstream of the terminal unit on those few zones closest to the central fan. This device could simply be a manual quadrant type damper if located well upstream of the terminal inlet. In tight quarters, perforated metal can be utilized as a quiet means of reducing system pressure. This approach allows all of the terminal units to experience a similar (lower) inlet pressure. They can be selected in a consistent manner at lower inlet pressure conditions that will allow more optimally sized units.

Inlet duct that is the same size as the inlet collar and as straight as possible will achieve the best acoustical performance. For critical applications, flexible duct should not be utilized at the terminal inlet.

**Zoning** On projects where internal lining of the downstream duct is not permitted, special considerations should be made to assure acceptable noise levels will be obtained. In these cases, a greater number of smaller zones will help in reducing sound levels. Where

possible, the first diffuser takeoff should be located after an elbow or tee and a greater number of small necked diffusers should be utilized, rather than fewer large necked diffusers.

The downstream ductwork should be carefully designed and installed to avoid noise regeneration. Bull head tee arrangements should be located sufficiently downstream of the terminal discharge to provide an established flow pattern downstream of the fan. Place diffusers downstream of the terminal after the airflow has completely developed.

Downstream splitter dampers can cause noise problems if placed too close to the terminal, or when excessive air velocities exist. If tee arrangements are employed, volume dampers should be used in each branch of the tee, and balancing dampers should be provided at each diffuser tap. This arrangement provides maximum flexibility in quiet balancing of the system. Casing radiated sound usually dictates the overall room sound levels directly below the terminal. Because of this, special consideration should be given to the location of these terminals as well as to the size of the zone. Larger zones should have the terminal located over a corridor or open plan office space and not over a small confined private office. Fan powered terminals should never be installed over small occupied spaces where the wall partitions extend from slab-to-slab (i.e. fire walls or privacy walls).

**Fan Terminal Isolation** Model CRC fan terminals are equipped with sufficient internal vibration dampening means to prevent the need for additional external isolation. Flexible duct connectors at the unit discharge typically do more harm than good. The sagging membrane causes higher air velocities and turbulence, which translates into noise. Furthermore, the discharge noise breaks out of this fitting more than with a hard sheet metal fitting.

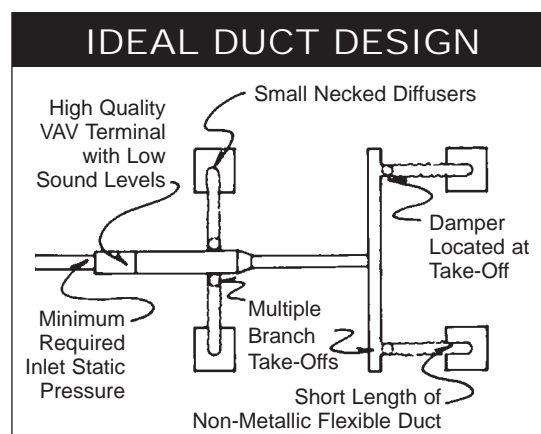

## APPLICATION AND SELECTION

---

### SELECTION GUIDELINES

The CRC fan terminal has been designed to provide maximum flexibility in matching primary air valve capacities (cooling loads) with unit fan capacities. The overall unit size is dictated by the fan size. With each unit fan size, multiple primary air valve sizes are available to handle a wide range of cooling capacities.

The fan should be sized first to determine the unit size. The selection is made by cross plotting the specified fan capacity and external static pressure on the appropriate fan performance curves. Terminals utilizing hot water heating coils and sensible cooling coils require the summation of the coil air pressure drop and the design E.S.P. to determine the total E.S.P. It is common to have more than one fan size which can meet the design requirements. Typically, the selection begins with the smallest fan that can meet the capacity. Occasionally this selection may not meet the acoustical requirements, and thus the next larger fan size should be selected.

Fan selections can be made anywhere in the non-shaded areas. Each fan performance curve depicts the actual performance of the relative motor without additional fan balance adjustment. After the proper fan is selected, the unit size is fixed and then the appropriate primary air valve is selected. Most of the unit fan sizes have three air valve sizes to select from. The middle size will typically be utilized. It is the size that is matched with the unit fan to deliver 100% cooling capacity for the majority of fan selections.

The larger primary air valve will be used in applications where the system fan is undersized, requiring a larger air valve to take advantage of lower pressure losses. While helping in this fashion, a penalty is paid by having a higher controllable minimum airflow setpoint than could be achieved with a smaller inlet size.

The smaller primary air valve will most often be utilized with thermal storage systems where lower than normal primary air temperatures are utilized. In these cases, the maximum design primary airflow is less than the fan capacity (typically 60 to 80%), and therefore a smaller air valve may be appropriate.

### SYSTEM PRESSURE CONSIDERATIONS

Since the terminal unit fan is selected to move 100% of the design airflow to the zone, all downstream pressure losses are neglected when determining minimum primary air inlet pressure to the unit. The central fan is only required to overcome the minimal loss through the unit air valve, reducing the central fan total pressure and horsepower requirements. Due to extremely low pressure drop of the air valve, central fan operating inlet static pressures may be as low as 0.5" w.g.

### COMMON MISAPPLICATION

It should be noted that a conventional Series Flow Fan Terminal cannot be applied as a booster fan. In problem areas where there is insufficient primary airflow capacity, this terminal will not aid in pulling more air from the primary duct. Instead the unit fan will draw air from the plenum inlet which has less resistance.

A web-based Computer Selection Program, Web-Select, is available to facilitate the selection process. Contact your representative to obtain access to this powerful and time-saving program.

# PRIMARY AIRFLOW CALIBRATION

**FLOWSTAR™ CALIBRATION CHART**  
(For dead-end differential pressure transducers)

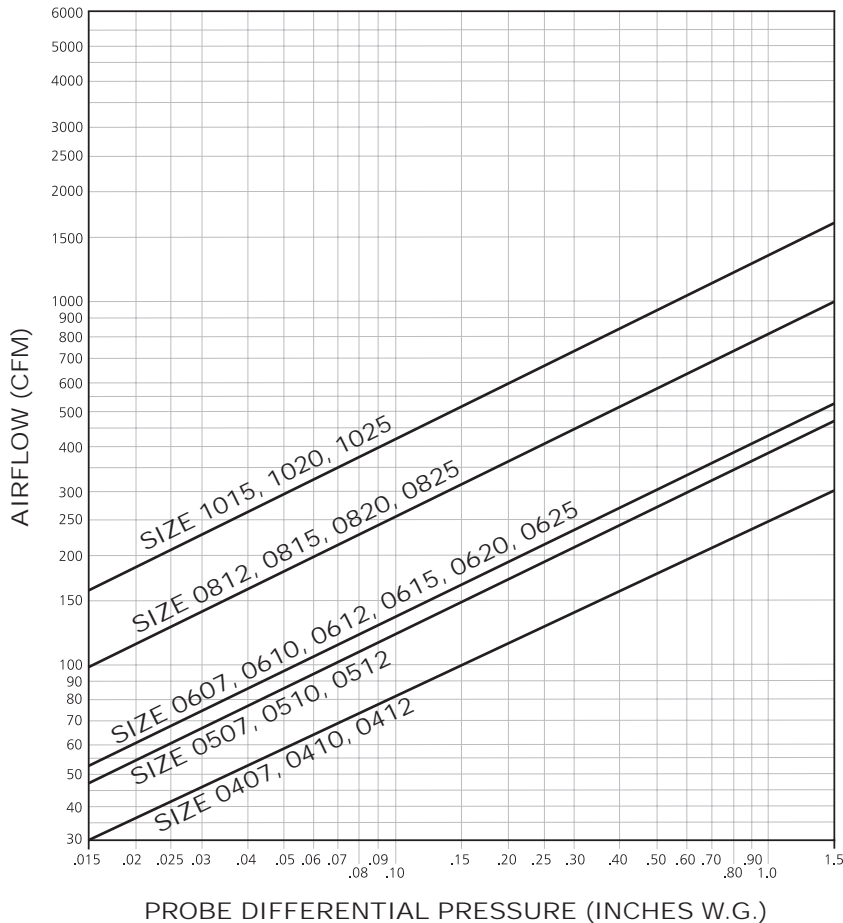

**NOTE:** Maximum and minimum CFM limits are dependent on the type of controls that are utilized. Refer to the table below for specific values. When DDC controls are furnished by others, the CFM limits are dependent on the specific control vendor that is employed. After obtaining the differential pressure range from the control vendor, the maximum and minimum CFM limits can be obtained from the chart above (many controllers are capable of controlling minimum setpoint down to .015" w.g.).

## AIRFLOW RANGES (CFM)

UNIT SIZE	DDC CONSIGNMENT CONTROLS				
	MIN.			MAX.	
	Minimum Transducer			Maximum Transducer	
	0.015	0.03	0.05	1.0	1.5
<b>0407, 0410, 0412</b>	30	43	55	248	304
<b>0507, 0510, 0512</b>	48	68	88	392	480
<b>0607, 0610, 0612, 0615, 0620, 0625</b>	53	75	97	433	530
<b>0812, 0815, 0820, 0825</b>	103	146	188	841	1030
<b>1015, 1020, 1025</b>	166	235	303	1355	1660

<sup>1</sup> Minimum and maximum airflow limits are dependent on the specific DDC controller supplied. Contact the control vendor to obtain the minimum and maximum differential pressure limits (inches W.G.) of the transducer utilized with the DDC controller.

<sup>2</sup> Maximum CFM is limited to value shown in General Selection Data.

# UNIT ARRANGEMENTS

## MODEL CRC WITH STANDARD CONTROL ENCLOSURE

Drawings are not to scale and not for submittal or installation purposes.

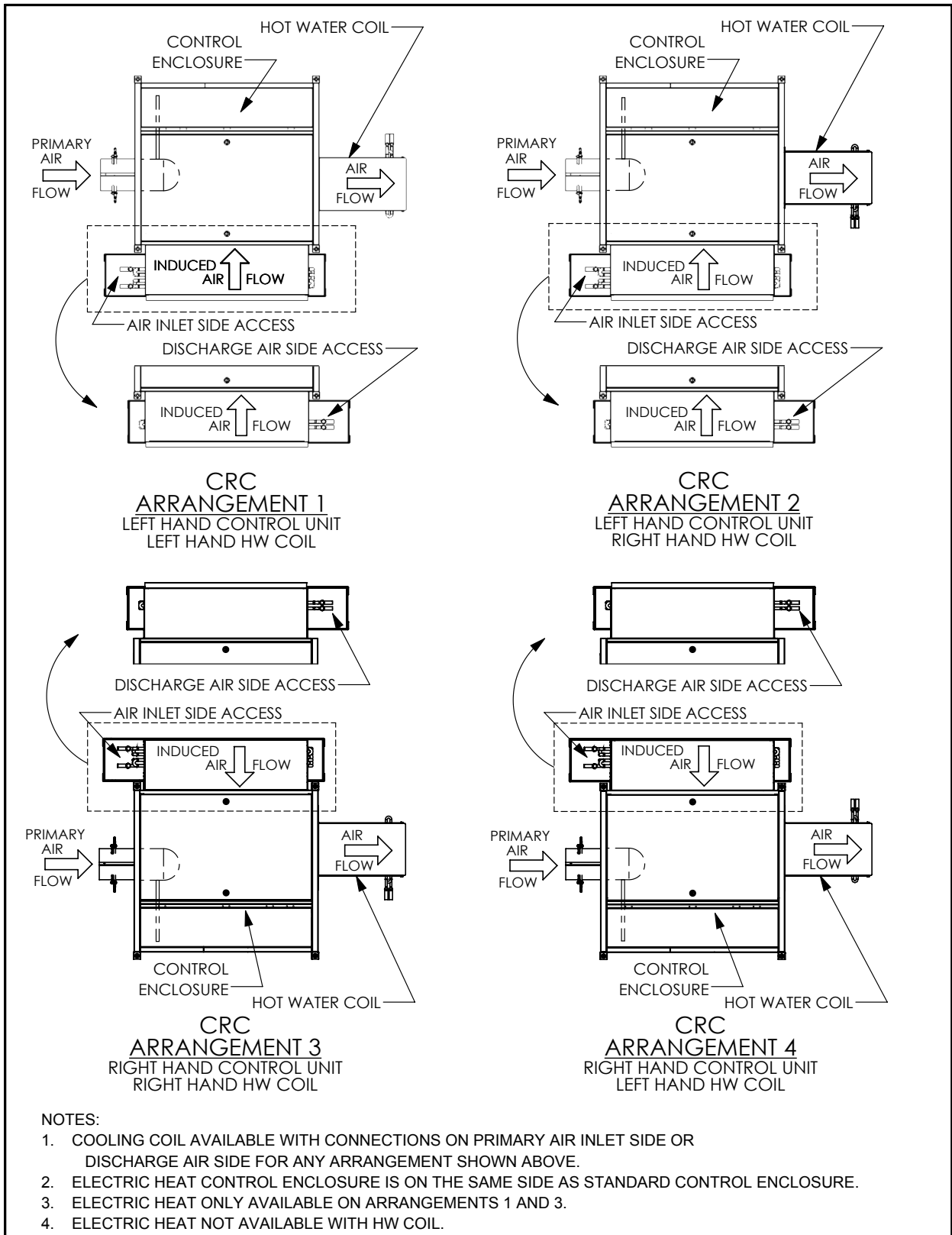

# UNIT ARRANGEMENTS

## MODEL CRC WITH 90° CONTROL ENCLOSURE

Drawings are not to scale and not for submittal or installation purposes.

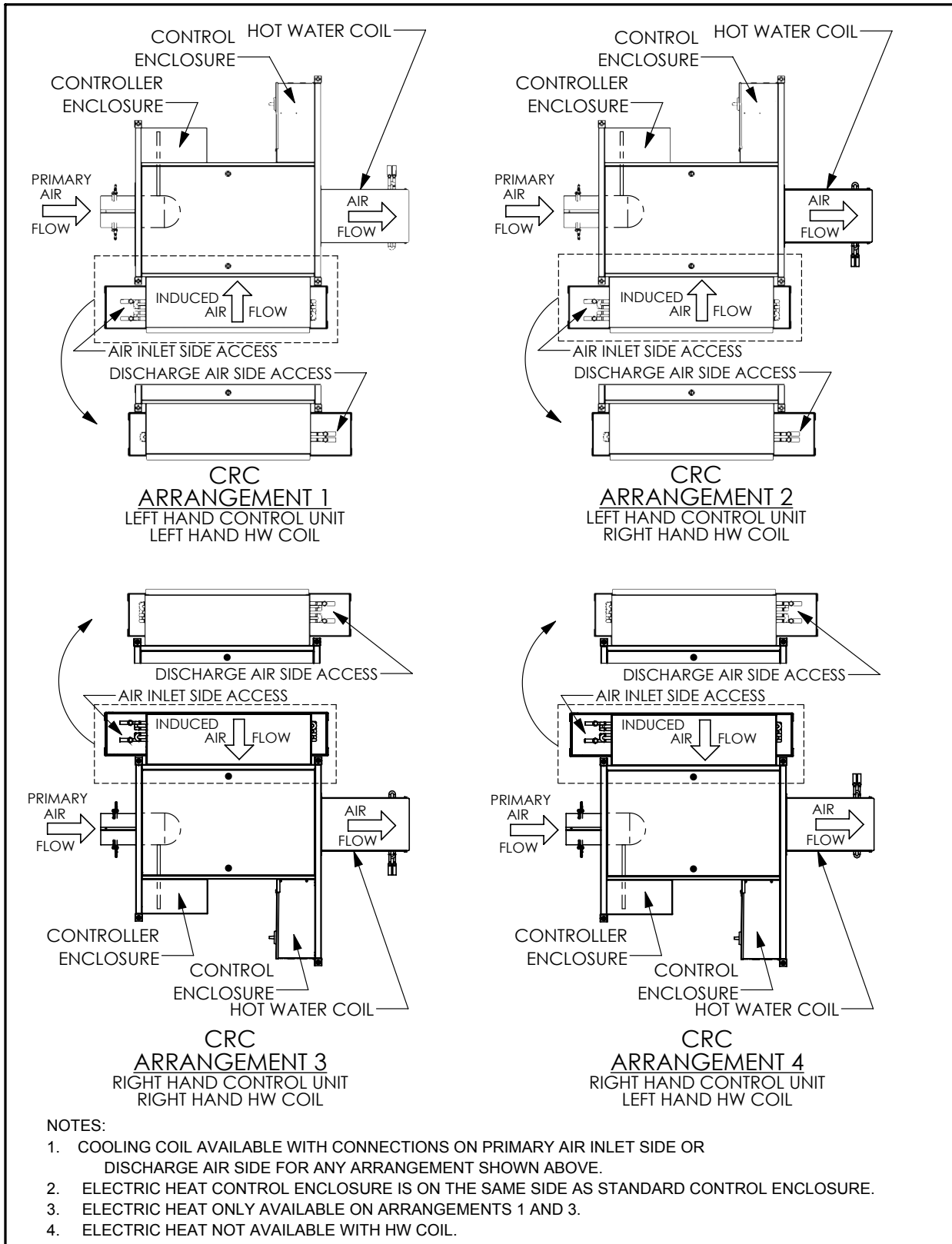

# DIMENSIONAL DATA

## MODEL CRC COOLING ONLY SIZES 07-25

Drawings are not to scale and not for submittal or installation purposes.

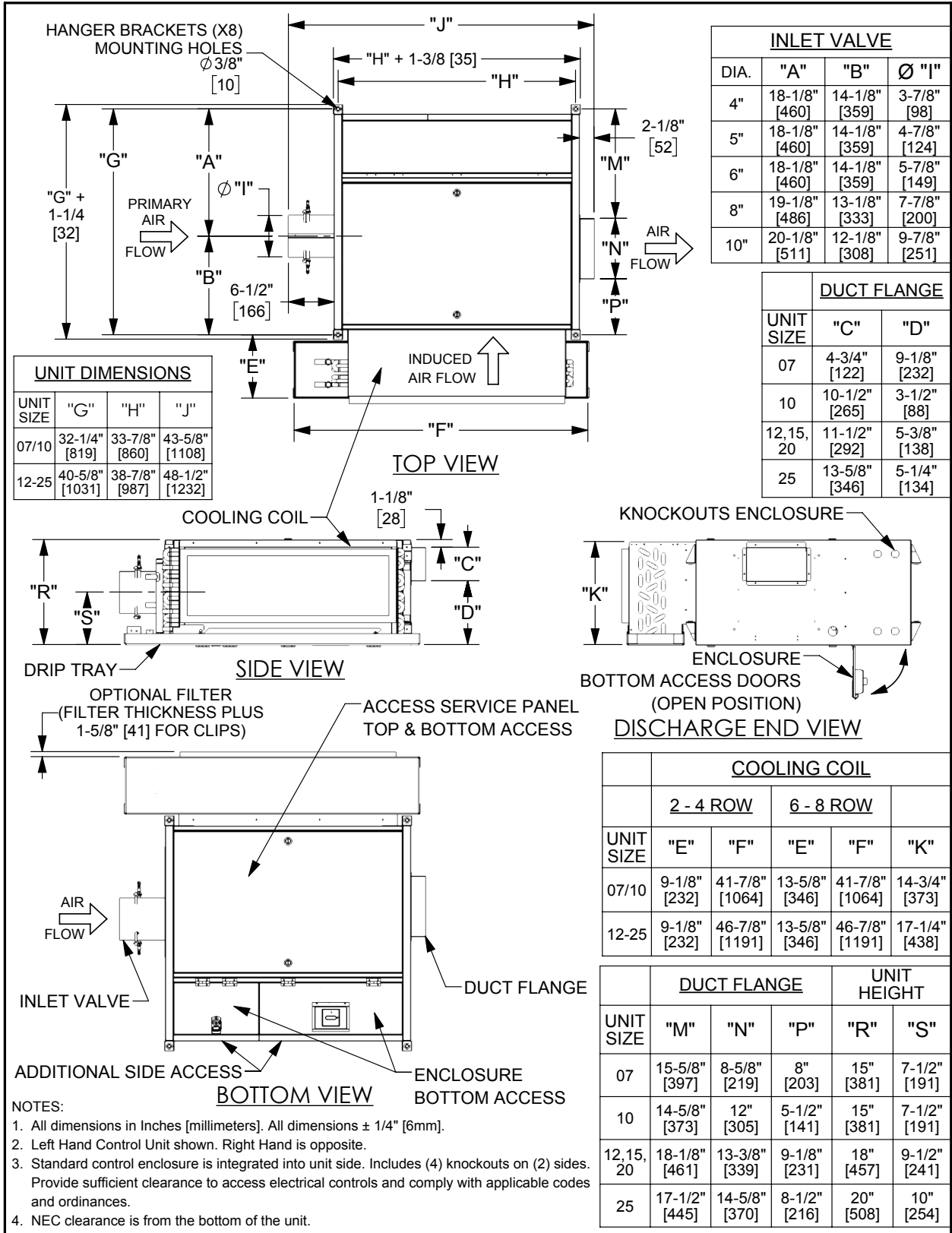

# DIMENSIONAL DATA

## MODEL CRC COOLING ONLY / 90° ENCLOSURE SIZES 07-25

Drawings are not to scale and not for submittal or installation purposes.

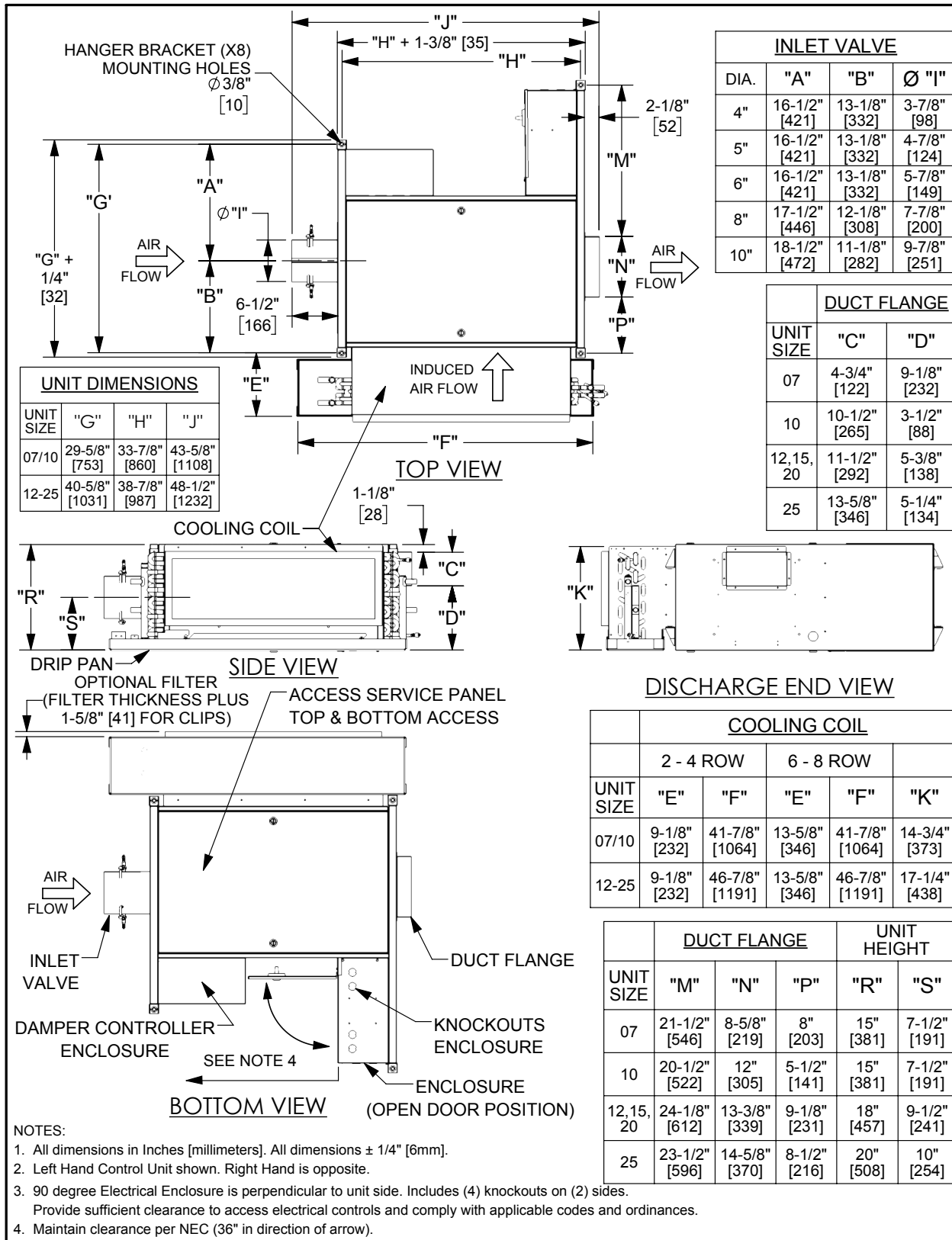



# DIMENSIONAL DATA

## MODEL CRC WITH HOT WATER COIL SIZES 07-25

Drawings are not to scale and not for submittal or installation purposes.

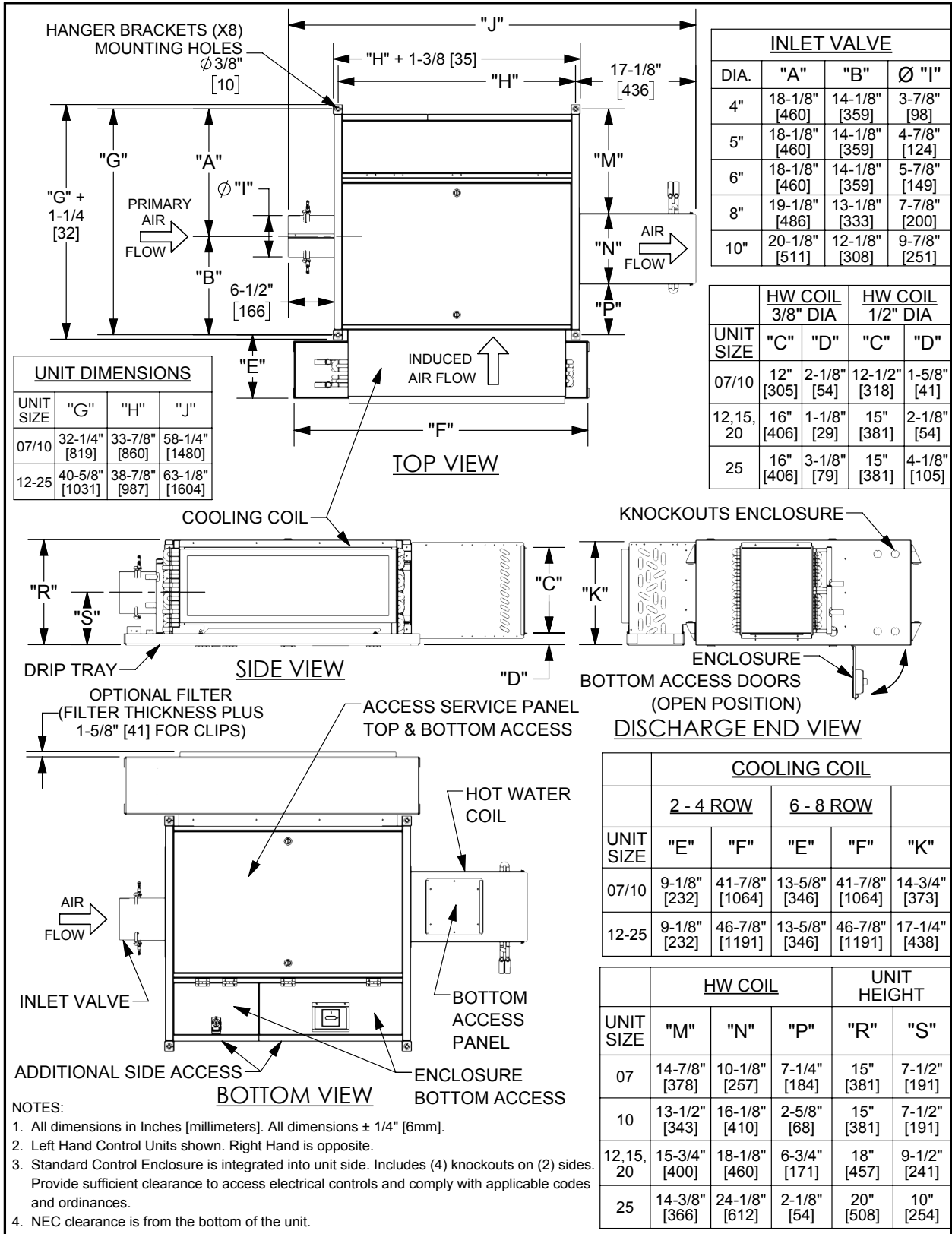

# DIMENSIONAL DATA

## MODEL CRC WITH HOT WATER COIL / 90° ENCLOSURE SIZES 07-25

Drawings are not to scale and not for submittal or installation purposes.

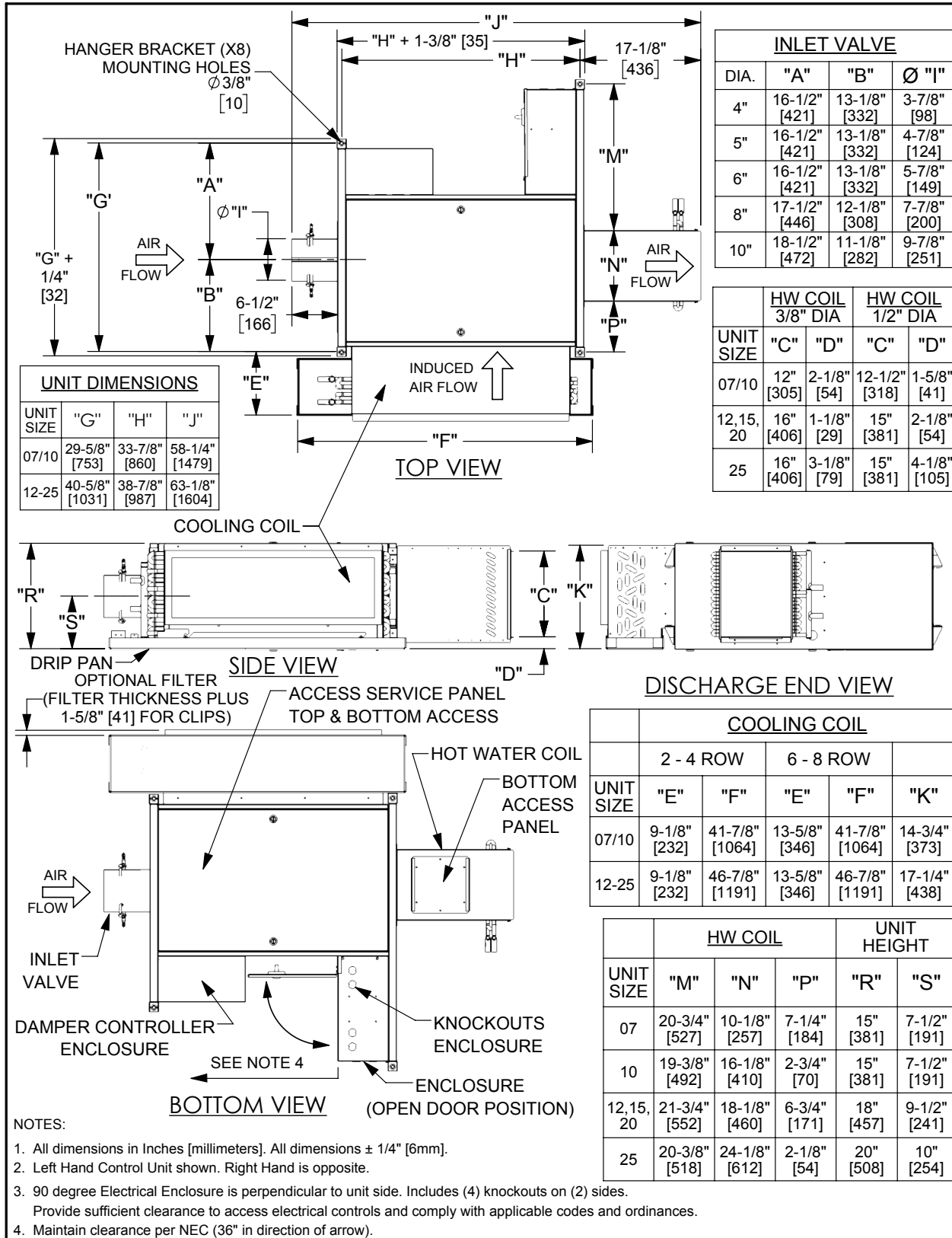

# DIMENSIONAL DATA

## MODEL CRC WITH ELECTRIC HEAT SIZES 07-25

Drawings are not to scale and not for submittal or installation purposes.

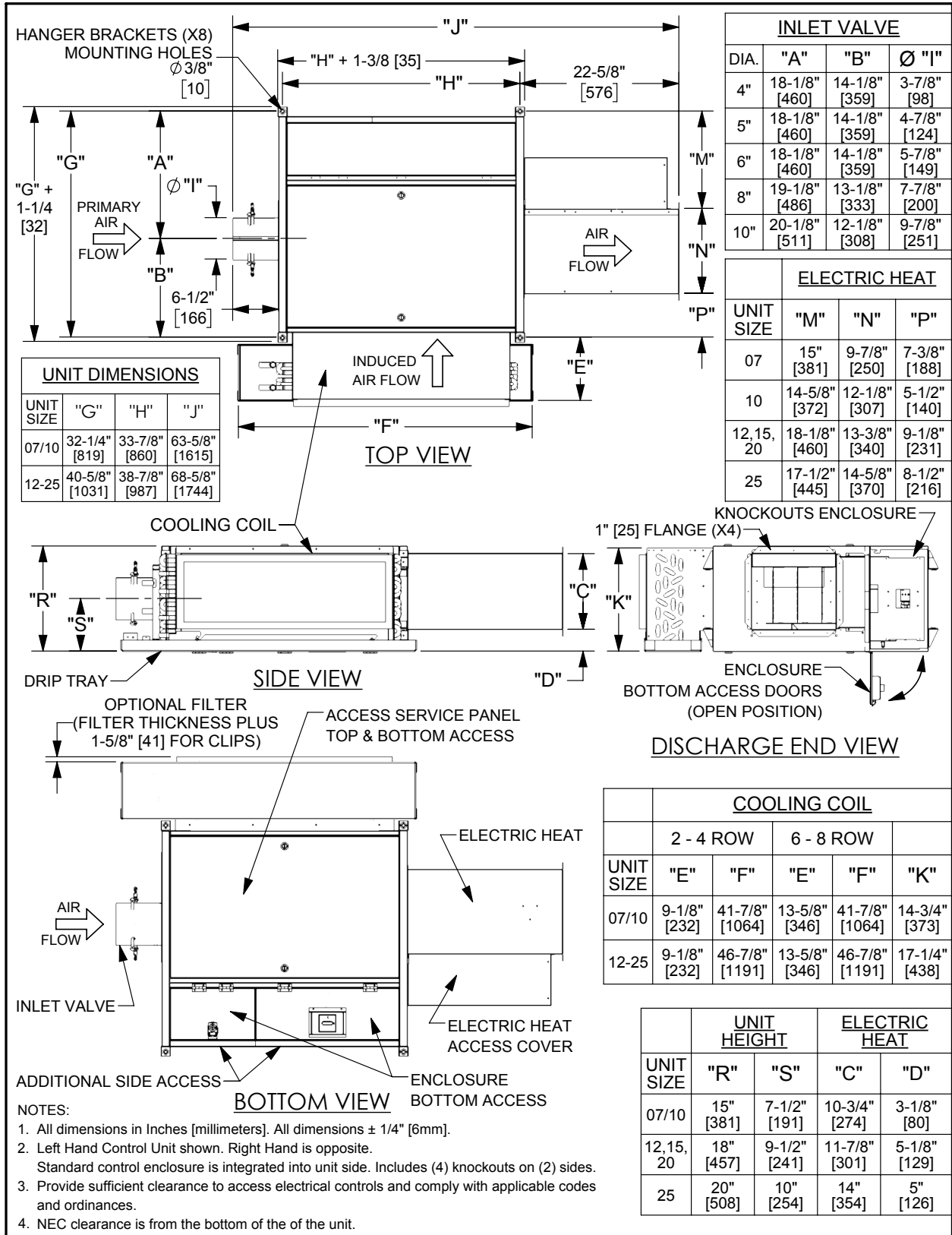

# DIMENSIONAL DATA

## MODEL CRC WITH ELECTRIC HEAT / 90° ENCLOSURE SIZES 07-25

Drawings are not to scale and not for submittal or installation purposes.

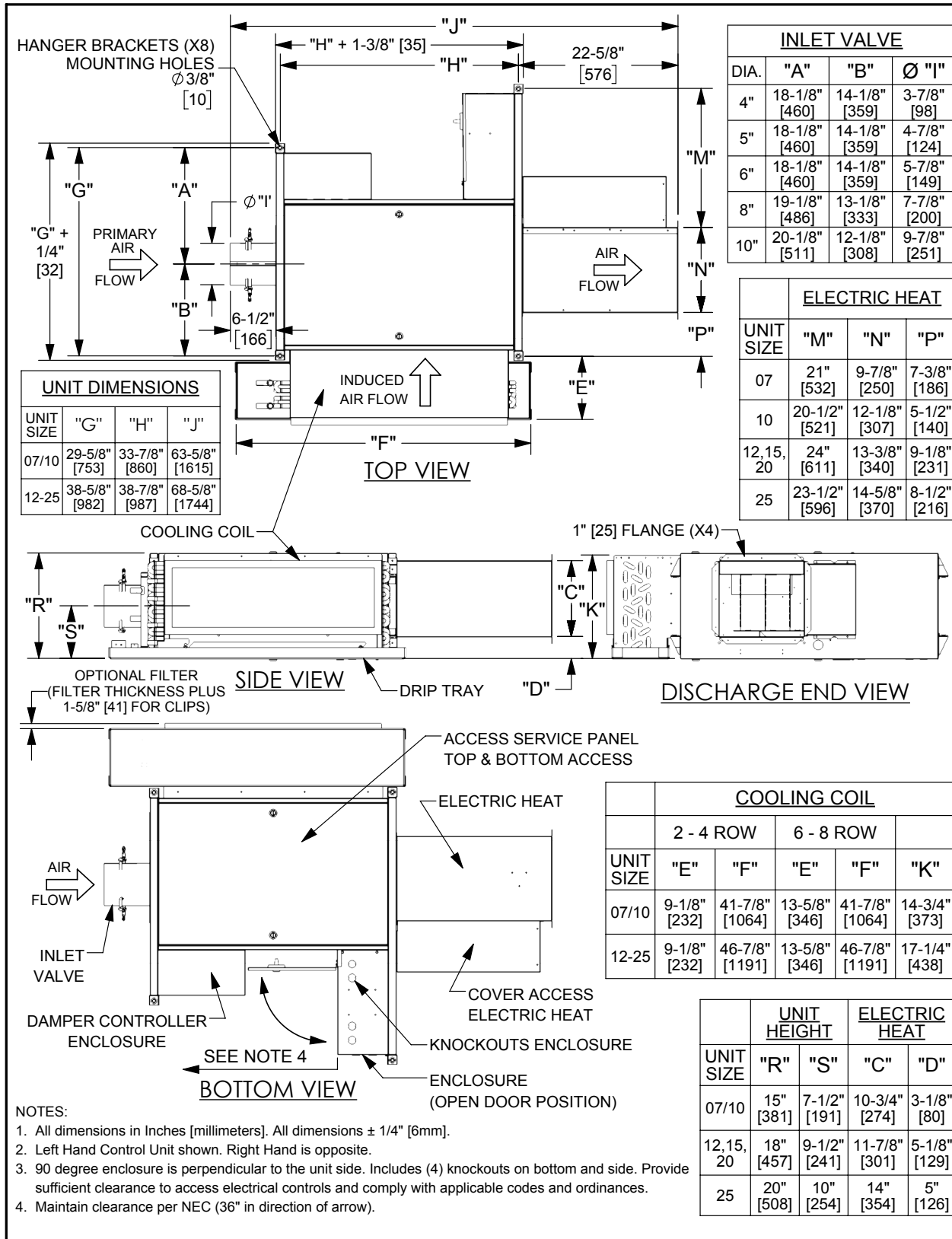





## EC FAN MOTOR OPTION

### THE ENERGY EFFICIENT SOLUTION

ENVIRO-TEC has long offered EC motors as a preferable alternative to the PSC motor due to the significant increase in the operating efficiency and controllability of fan terminal units. This motor is frequently referred to as an ECM (electronically commutated motor). It is a brushless DC (BLDC) motor utilizing a permanent magnet rotor. The motor is commonly used in almost every segment of the HVAC industry. Fan control is accomplished through a microprocessor-based inverter which is integral to the motor. The motor provides peak efficiency ratings between 70 to 80% for most applications.

### EC MOTOR FEATURES AND BENEFITS

#### Ultra-High Motor & Controller Energy Efficiency

The EC motor is typically 20% more efficient than a standard induction motor, at full load. Due to acoustical considerations, the fan motor on a fan powered terminal typically operates considerably less than full load. At this condition the overall motor/controller efficiency of a PSC motor can be cut in half. Due to the permanent magnet, DC design, the EC motor maintains a high efficiency at low speeds. Most fan powered unit selections will have an overall efficiency greater than 75%. Furthermore, the motor heat gain is greatly reduced, providing additional energy savings by reducing the cold primary air requirement.

#### Fan Operating Mode

Series Flow Terminals with EC motors are available as pressure independent (constant airflow) or constant torque. Constant airflow operation has been very popular in fan powered VAV. It allows the motor to vary speed and torque in response to changes in external conditions, without the need for additional sensors. Constant torque allows the motor to vary speed, but lets the VAV controller determine torque. This limits energy usage by giving the VAV controller greater authority over motor operation.

#### Fan Control Options

Series Flow Terminals with EC motors are available with two control methods. In single-phase applications, either operating mode is available with either control method.

An electronic pulse width modulation (PWM) speed control device is provided to interface between the motor and the VAV controller. Fan volume can be calibrated depending on the type of PWM control board provided on the unit.

For the Solo PWM board, a potentiometer is provided, allowing manual adjustment by the use of an instrument-type screwdriver. If a Sync PWM board is provided, the fan volume can be calibrated through the BMS, using an analog output (2-10VDC typical) to the speed controller. A fan volume versus DC volts calibration chart is provided to allow field changes of the fan capacity as the need arises.

#### Designer / Owner Flexibility

The EC motor incorporates ball bearings in lieu of sleeve bearings typically utilized with an induction motor. As a result, the EC motor has a lower minimum RPM requirement for bearing lubrication. This allows it to operate over a wider speed range. One motor can handle the capacity range which was previously handled by two motors, allowing simplification of the product line, and considerable flexibility to the designer. The owner also benefits since equipment changes are much less likely with tenant requirement changes. A reduced spare parts inventory is yet another plus.



#### Custom Applications: Programmable Fan Operation

Boundless control opportunities arise due to the controllability of a DC motor combined with an integral microprocessor. Various input signals can direct the motor to behave in an application specific mode. For instance, multiple discrete fan capacities can be achieved. In addition, the fan speed can be varied in response to the space temperature load. The fan can also be programmed for a soft start. The motor starts at a very low speed and slowly ramps up to the required speed.

#### Extended Motor Life

The high motor efficiency provides a significantly reduced operating temperature compared to an induction motor. The lower temperature increases the longevity of all electrical components, and therefore, the life of the motor. The ball bearings do not require lubrication and do not adversely impact the motor life. Most fan powered applications will provide a motor life between 60,000 and 100,000 hours. A motor life of twenty five years will not be uncommon for a series flow fan terminal.

## GENERAL SELECTION, EC MOTOR

---

Most variable speed electronic devices, including the EC motor, operate with a rectified and filtered AC power. As a result of the power conditioning, the input current draw is not sinusoidal; rather, the current is drawn in pulses at the peaks of the AC voltage. This pulsating current includes high frequency components called harmonics.

Harmonic currents circulate on the delta side of a Delta-Wye distribution transformer. On the Wye side of the transformer, these harmonic currents are additive on the neutral conductor. A transformer used in this type of application must be sized to carry the output KVA that will include the KVA due to circulating currents.

Careful design must be provided when connecting single-phase products to three-phase systems to avoid potential problems such as overheating of neutral wiring conductors, connectors, and transformers. In addition, design consideration must be provided to address the degradation of power quality by the creation of wave shape distortion.

In summary, proper consideration must be given to the power distribution transformer selection and ground neutral conductor design to accommodate the 3-phase neutral AMPs shown in the adjacent table. Specific guidelines are available from the factory.



# FAN AND MOTOR DATA

Combined ECM & PSC						
CRB/CRQ/CRC (CRC is ECM only)						
Fan Size	Fan HP	Motor Phase	Voltage	FLA		
				ECM-kTq	ECM-kAF	PSC
07	1/4 - kTq	1	115	3.5	4.3	4.0
	1/3 - kAF		208-240	2.1	2.8	-
	1/4 - PSC		277	1.6	2.2	1.6
10	1/3	1	115	5.0	5.0	11.3
			208-240	3.0	3.0	-
			277	2.6	2.6	3.8
	1/2	3	480	1.0	-	-
12	1/3	1	115	5.0	5.0	11.3
			208-240	3.0	3.0	-
			277	2.3	2.3	3.8
	1/2	3	480	1.0	-	-
15	1/2 - ECM 1/3 - PSC	1	115	6.7	7.0	11.3
			208-240	4.3	4.5	-
			277	3.3	3.6	3.8
		3	480	1.0	-	-
20	3/4	1	115	9.6	9.6	14.2
			208-240	6.6	6.7	-
			277	5.0	5.2	5.4
	1	3	480	1.8	-	-
25	1	1	115	12.0	12.0	-
			208-240	8.1	7.9	-
			277	6.2	5.9	7.2
		3	480	1.8	-	-
35	(2) 1/2 - ECM (2) 1 - PSC	1	115	11.4	12.2	-
			208-240	7.4	7.6	-
			277	5.6	5.8	14.4
		3	480	2.0	-	-
45	(2) 1	1	115	24.4	23.0	-
			208-240	15.4	14.0	-
			277	11.6	10.6	14.4
		3	480	3.5	-	-

**NOTES:**

1. Size 35 and 45 CRB and CRQ only.
2. For three-phase conductor sizing, multiply FLA by 1.73.

# FAN PERFORMANCE, EC MOTOR

## GENERAL FAN NOTE

The fan curves depicted on this page are for EC motors. Actual specified capacities which fall below the fan curve can be obtained by adjustment of the fan speed controller. The minimum external static pressure requirement is shown for each fan assembly. The unit fan should not be energized prior to realizing this minimum external static pressure.

Charts include 4-row, 1/2" tube, 10FPI cooling coil. Refer to Web-Select for other coil options. Terminals equipped with a hot water heating coil require the addition of the coil pressure drop to the specified external static pressure before making the fan selection.

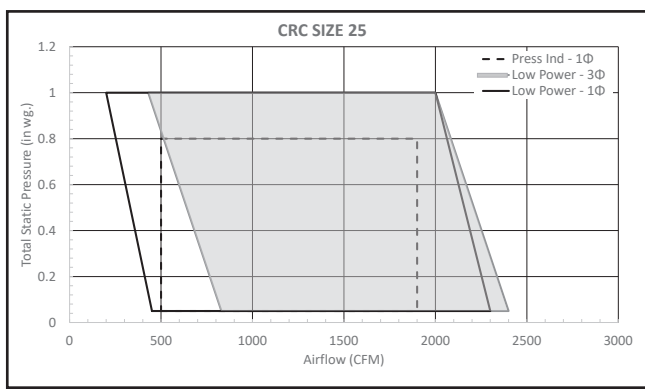
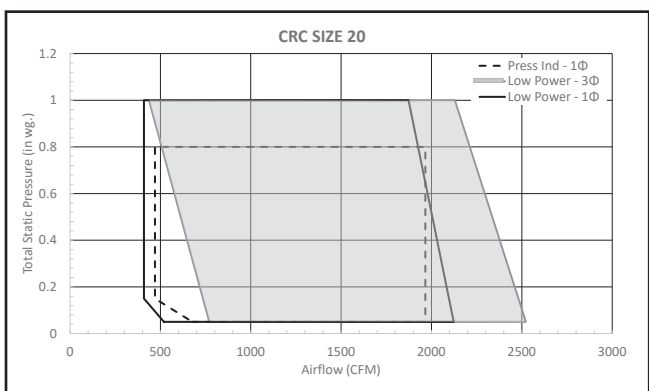
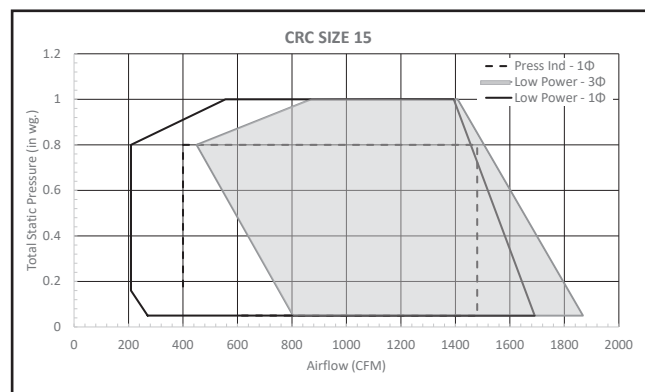
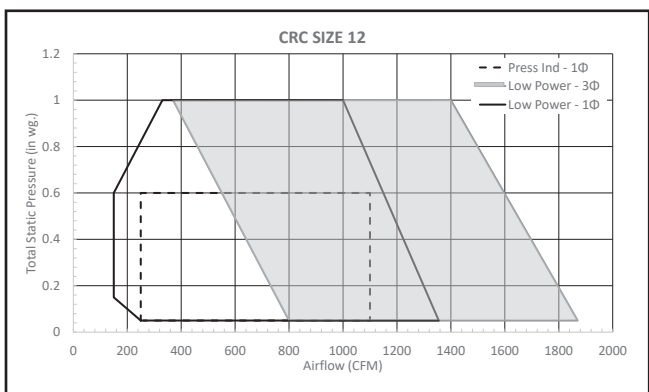
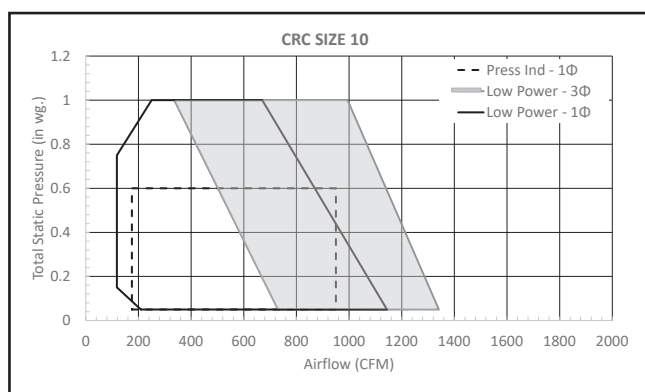
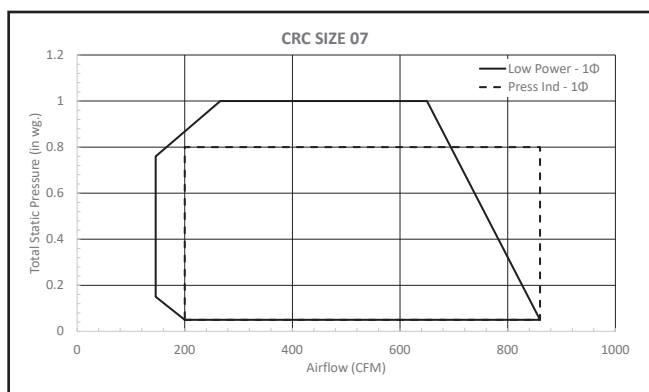

# ELECTRIC HEAT

## MODEL CRC-EH

### STANDARD FEATURES

- cETL listed as an assembly for safety compliance per UL 1995
- Primary auto-reset high limit
- Secondary high limit
- Ni-Chrome elements
- Primary/secondary power terminations
- Fusing per NEC
- Wiring diagram and ETL label
- Fan interlock device (relay or P.E. switch)
- Single point power connection
- Available kW increments are as follows:  
0.5 to 5.0 kW: 0.5kW / above 5.0kW: 1.0 kW

### OPTIONAL FEATURES

- Disconnect (door interlocking)
- P.E. switches
- Manual reset secondary limit
- Proportional control (SSR)
- 24VAC control transformer
- Airflow switch

### MAXIMUM ALLOWABLE kW

UNIT SIZE	NOM CFM*	MAX kW
07	780	7
10	1000	14
12	1350	17
15	1700	20
20	2050	28
25	2500	28

\* 0.25 external static pressure



### SELECTION PROCEDURE

With standard heater elements, the maximum capacity (kW) is obtained by dividing the heating (fan) SCFM by 70. In other words, the terminal must have at least 70 SCFM per kW. In addition, each size terminal has a maximum allowable kW based upon the specific heater element configuration (i.e. voltage, phase, number of steps, etc.). Contact your representative or refer to web-based Computer Selection Program Web-Select for design assistance.

Heaters require a minimum of 0.07" w.g. downstream static pressure to ensure proper operation.

For optimum diffuser performance in overhead heating applications, the supply air temperature should be within 20°F of the desired space temperature. This typically requires a higher air capacity which provides higher air motion in the space increasing thermal comfort. The electric heater should be selected with this in mind, keeping the LAT as low as possible.

### Selection Equations

$$\text{kW} = \frac{\text{SCFM} \times \Delta T \times 1.085^*}{3413}$$

$$\text{CFM} = \frac{\text{kW} \times 3413}{\Delta T \times 1.085^*}$$

$$\Delta T = \frac{\text{kW} \times 3413}{\text{SCFM} \times 1.085^*}$$

\* Air density at sea level - reduce by 0.036 for each 1000 feet of altitude above sea level.

### Calculating Line Amperage

$$\text{Single Phase Amps} = \frac{\text{kW} \times 1000}{\text{Volts}}$$

$$\text{Three Phase Amps} = \frac{\text{kW} \times 1000}{\text{Volts} \times 1.73}$$

## SENSIBLE COOLING COIL DATA

---

### MODEL CRC-WC

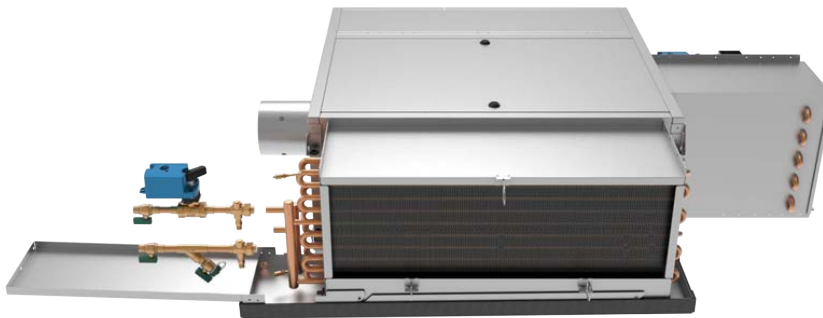

#### STANDARD FEATURES

- Coils are designed, manufactured, and tested by ENVIRO-TEC
- Aluminum fin construction with die-formed spacer collars for uniform spacing
- Mechanically expanded copper tubes, leak tested to 450 PSIG air pressure and rated at 450 PSIG working pressure at 200°F
- 2, 3, 4, 6 and 8 row configurations
- Male sweat type water connections

#### OPTIONAL FEATURES

- Hot water coil
- Multi-circuit coils for reduced water pressure drop
- Opposite hand water connections

#### DEFINITION OF TERMS

<b>EAT</b>	Entering Air Temperature (°F)
<b>LAT</b>	Leaving Air Temperature (°F)
<b>EWT</b>	Entering Water Temperature (°F)
<b>LWT</b>	Leaving Water Temperature (°F)
<b>CFM</b>	Air Capacity (Cubic Feet per Minute)
<b>GPM</b>	Water Capacity (Gallons per Minute)
<b>MBH</b>	1,000 BTUH
<b>BTUH</b>	Coil Cooling Capacity (British Thermal Units per Hour)
<b>ΔT</b>	EWT minus EAT

#### SELECTION PROCEDURE

For specific data points based on unit size and coil rows, please use the web-select selection tool. Web-select allows the user to choose a coil based on specific requirements, and outputs tabulated data which can be used in submittal or engineering presentations.

A web-based Computer Selection Program, Web-Select, is available to facilitate the selection process. Contact your representative to obtain access to this powerful and time-saving program.

# SENSIBLE COOLING COIL DATA

## MODEL CRC UNIT SIZES 0407, 0507, 0607

### 2 ROW - 1/2" COIL TUBES

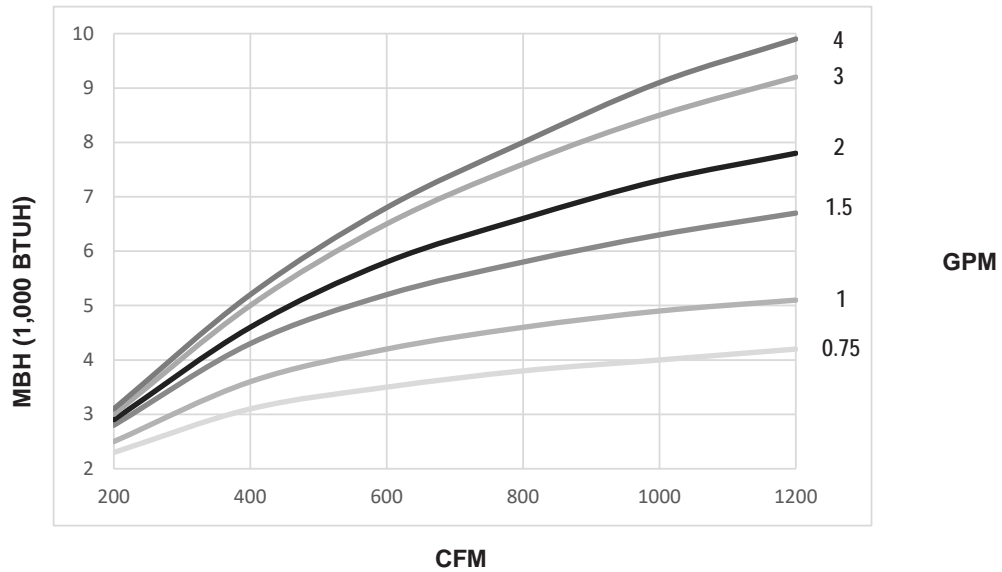

### 4 ROW - 1/2" COIL TUBES

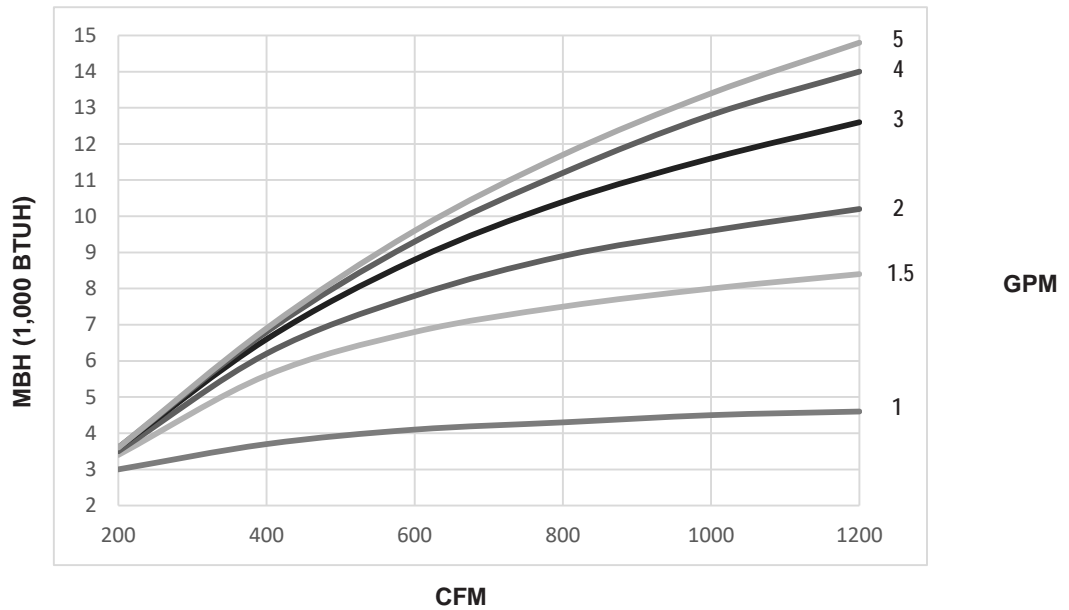

**NOTES:**

1. Data is based on 57°F entering water and 75°F entering air temperature at sea level. Entering wet bulb must be lower than entering water temperature for sensible cooling-only applications.
2. Coils have 0.50" tubes and 12 fins per inch. Alternate tube size, fin density, and circuiting options are available in Web-Select.

A web-based Computer Selection Program, Web-Select, is available to facilitate the selection process. Contact your representative to obtain access to this powerful and time-saving program.

# SENSIBLE COOLING COIL DATA

## MODEL CRC UNIT SIZES 0407, 0507, 0607

6 ROW - 1/2" COIL TUBES

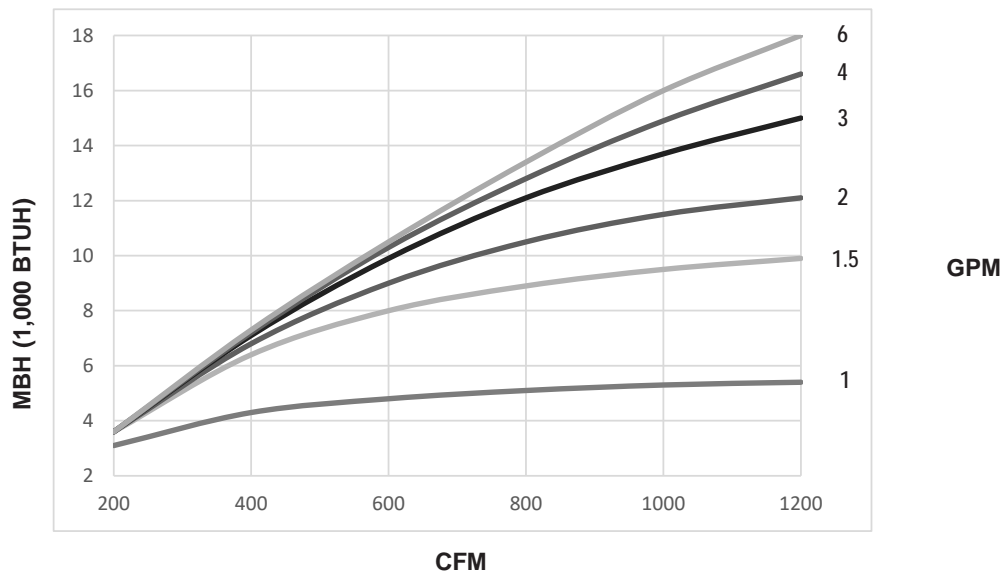

8 ROW - 1/2" COIL TUBES

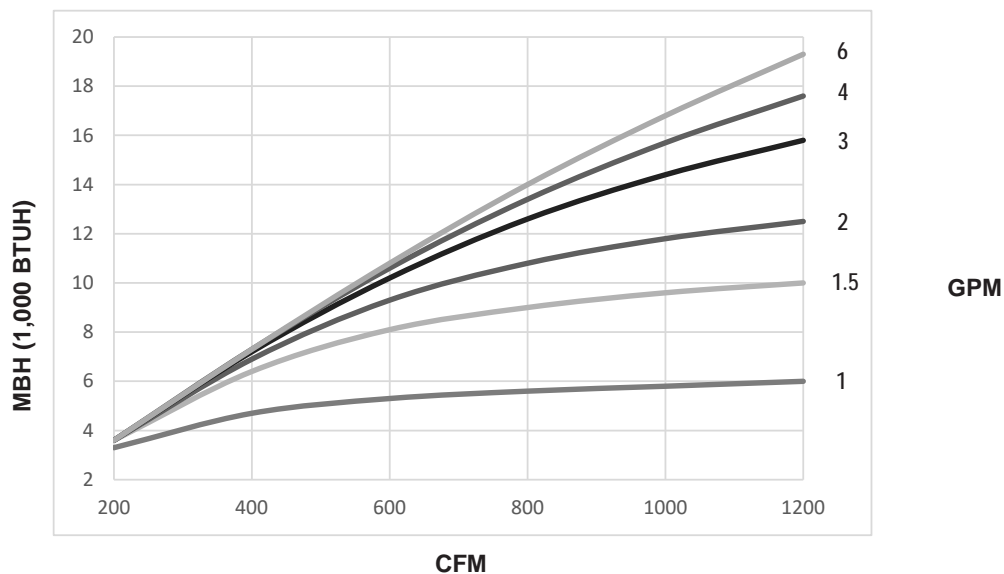

**NOTES:**

1. Data is based on 57°F entering water and 75°F entering air temperature at sea level. Entering wet bulb must be lower than entering water temperature for sensible cooling-only applications.
2. Coils have 0.50" tubes and 12 fins per inch. Alternate tube size, fin density, and circuiting options are available in Web-Select.

A web-based Computer Selection Program, Web-Select, is available to facilitate the selection process. Contact your representative to obtain access to this powerful and time-saving program.

# SENSIBLE COOLING COIL DATA

## MODEL CRC UNIT SIZES 0410, 0510, 0610

### 2 ROW - 1/2" COIL TUBES

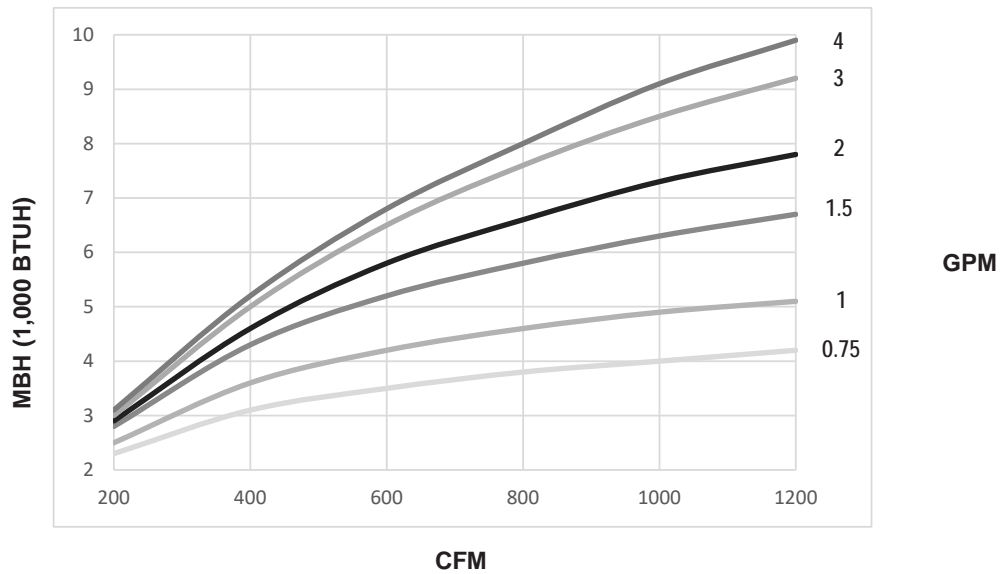

### 4 ROW - 1/2" COIL TUBES

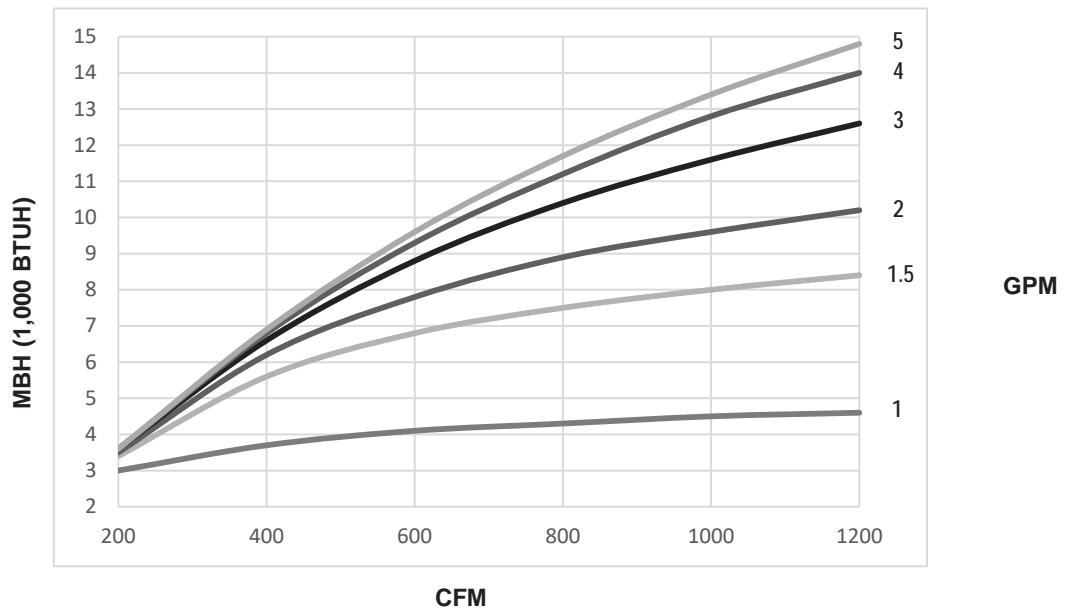

**NOTES:**

1. Data is based on 57°F entering water and 75°F entering air temperature at sea level. Entering wet bulb must be lower than entering water temperature for sensible cooling-only applications.
2. Coils have 0.50" tubes and 12 fins per inch. Alternate tube size, fin density, and circuiting options are available in Web-Select.

A web-based Computer Selection Program, Web-Select, is available to facilitate the selection process. Contact your representative to obtain access to this powerful and time-saving program.

# SENSIBLE COOLING COIL DATA

## MODEL CRC UNIT SIZES 0410, 0510, 0610

6 ROW - 1/2" COIL TUBES

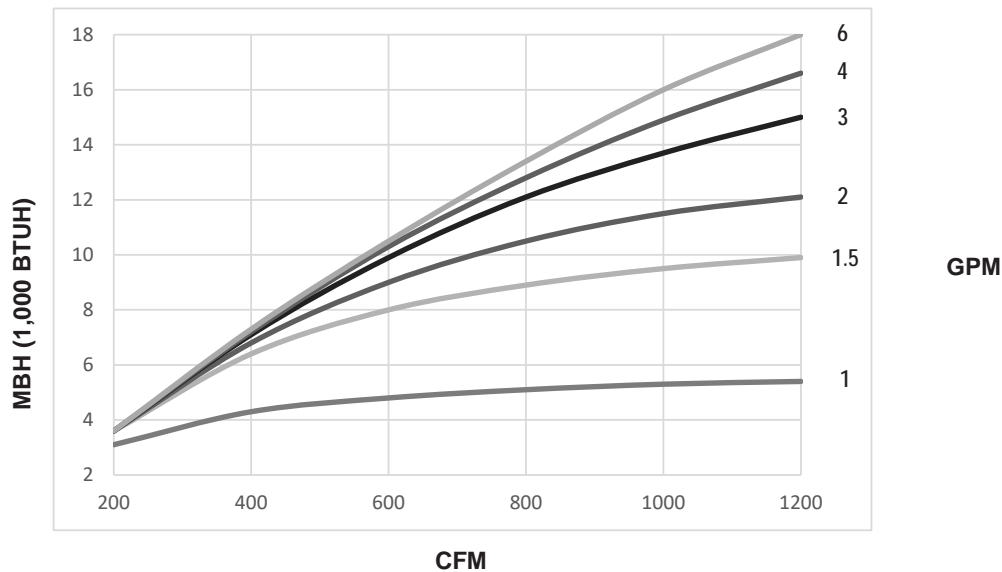

8 ROW - 1/2" COIL TUBES

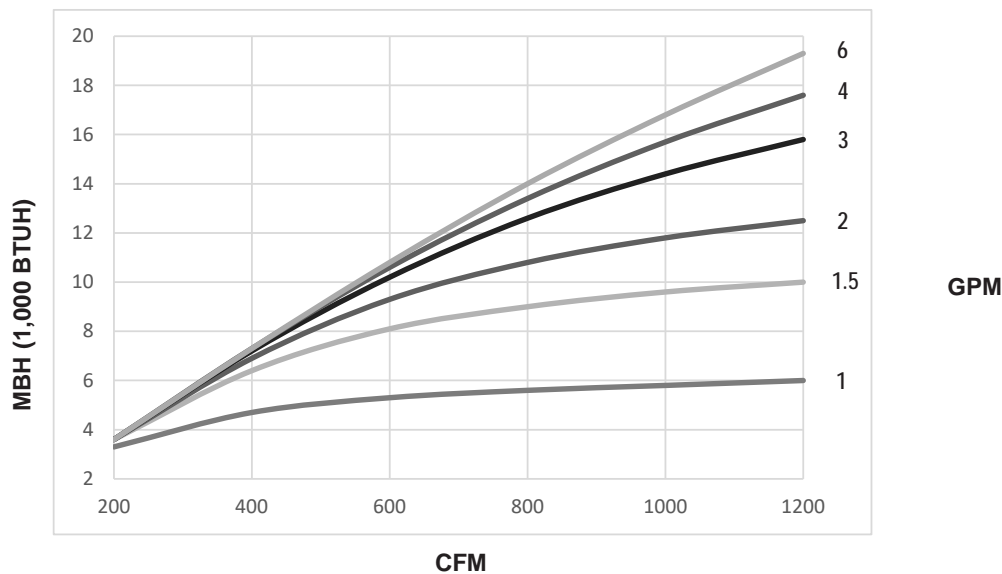

**NOTES:**

1. Data is based on 57°F entering water and 75°F entering air temperature at sea level. Entering wet bulb must be lower than entering water temperature for sensible cooling-only applications.
2. Coils have 0.50" tubes and 12 fins per inch. Alternate tube size, fin density, and circuiting options are available in Web-Select.

A web-based Computer Selection Program, Web-Select, is available to facilitate the selection process. Contact your representative to obtain access to this powerful and time-saving program.



# SENSIBLE COOLING COIL DATA

## MODEL CRC UNIT SIZES 0412, 0512, 0612, 0812

2 ROW - 1/2" COIL TUBES

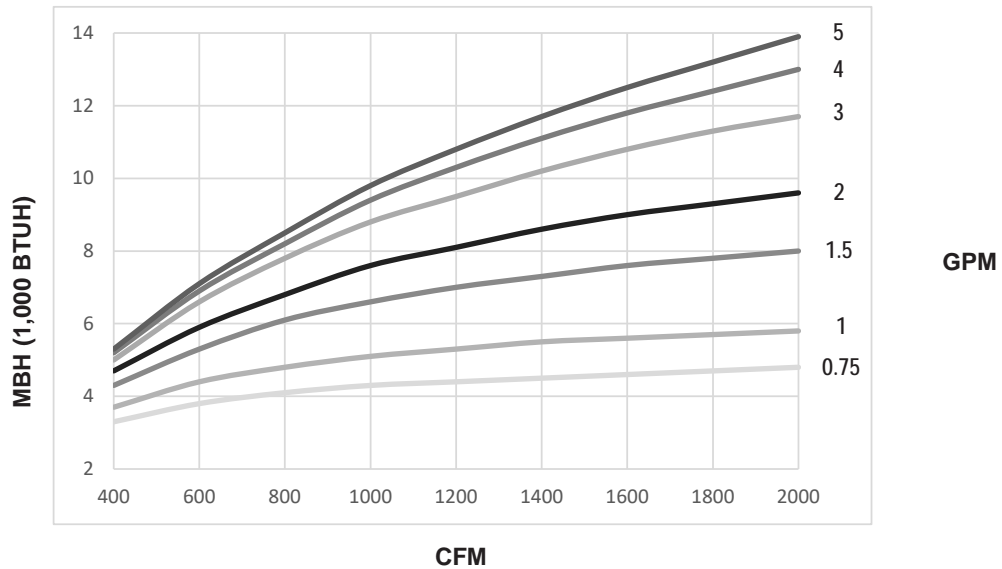

4 ROW - 1/2" COIL TUBES

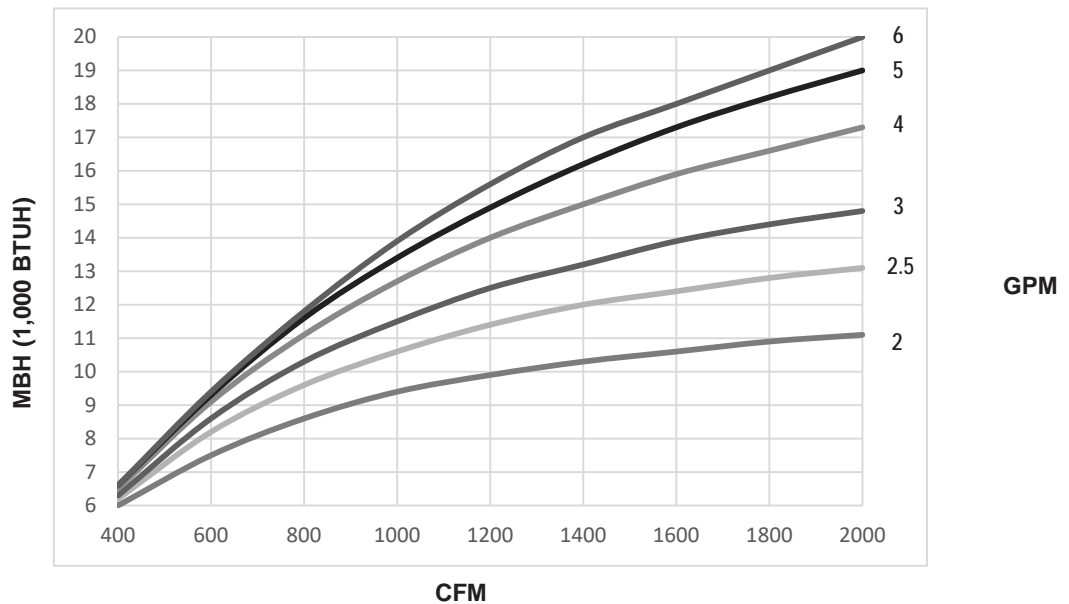

**NOTES:**

1. Data is based on 57°F entering water and 75°F entering air temperature at sea level. Entering wet bulb must be lower than entering water temperature for sensible cooling-only applications.
2. Coils have 0.50" tubes and 12 fins per inch. Alternate tube size, fin density, and circuiting options are available in Web-Select.

A web-based Computer Selection Program, Web-Select, is available to facilitate the selection process. Contact your representative to obtain access to this powerful and time-saving program.

# SENSIBLE COOLING COIL DATA

## MODEL CRC UNIT SIZES 0412, 0512, 0612, 0812

6 ROW - 1/2" COIL TUBES

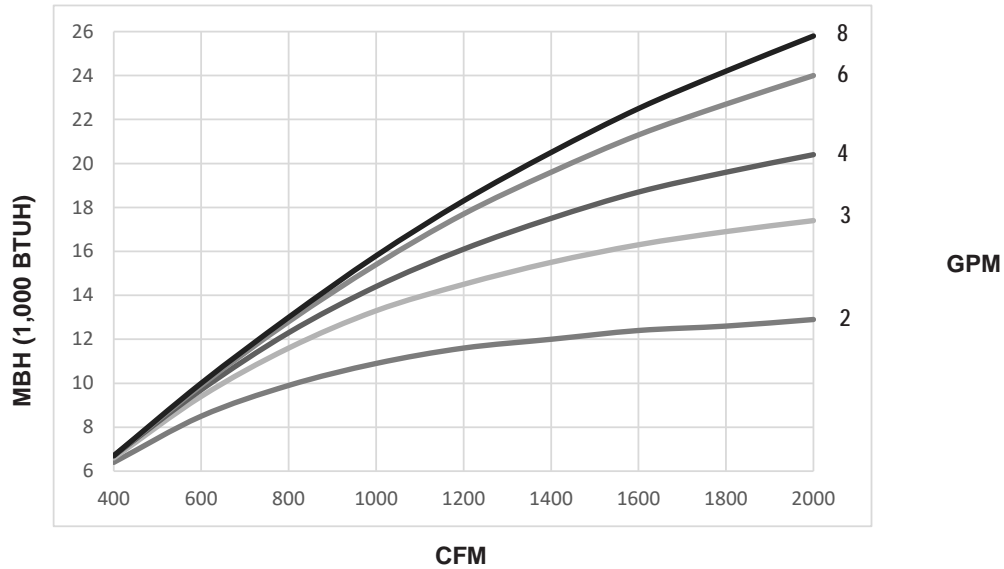

8 ROW - 1/2" COIL TUBES

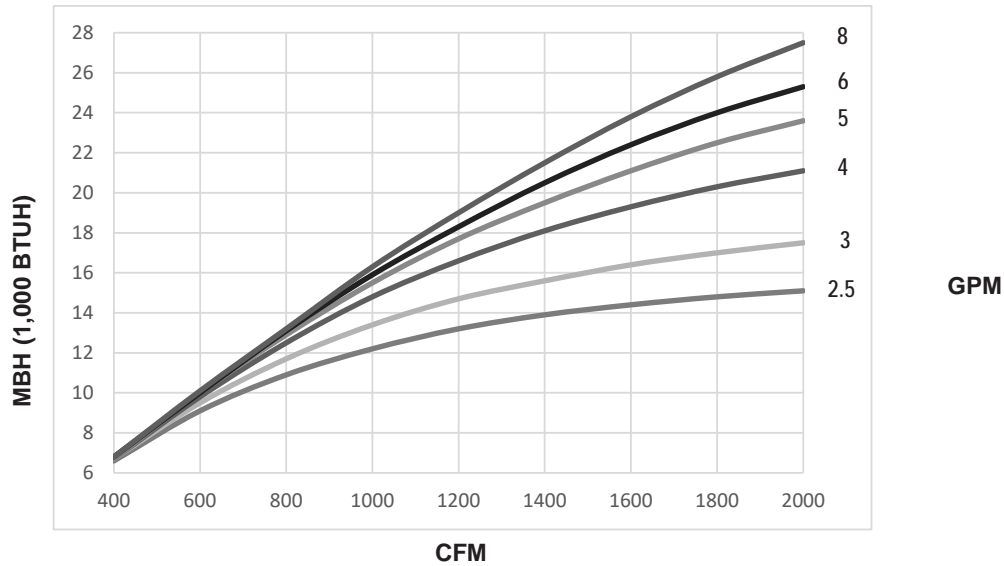

**NOTES:**

1. Data is based on 57°F entering water and 75°F entering air temperature at sea level. Entering wet bulb must be lower than entering water temperature for sensible cooling-only applications.
2. Coils have 0.50" tubes and 12 fins per inch. Alternate tube size, fin density, and circuiting options are available in Web-Select.

A web-based Computer Selection Program, Web-Select, is available to facilitate the selection process. Contact your representative to obtain access to this powerful and time-saving program.

# SENSIBLE COOLING COIL DATA

## MODEL CRC UNIT SIZES 0615, 0815, 1015

### 2 ROW - 1/2" COIL TUBES

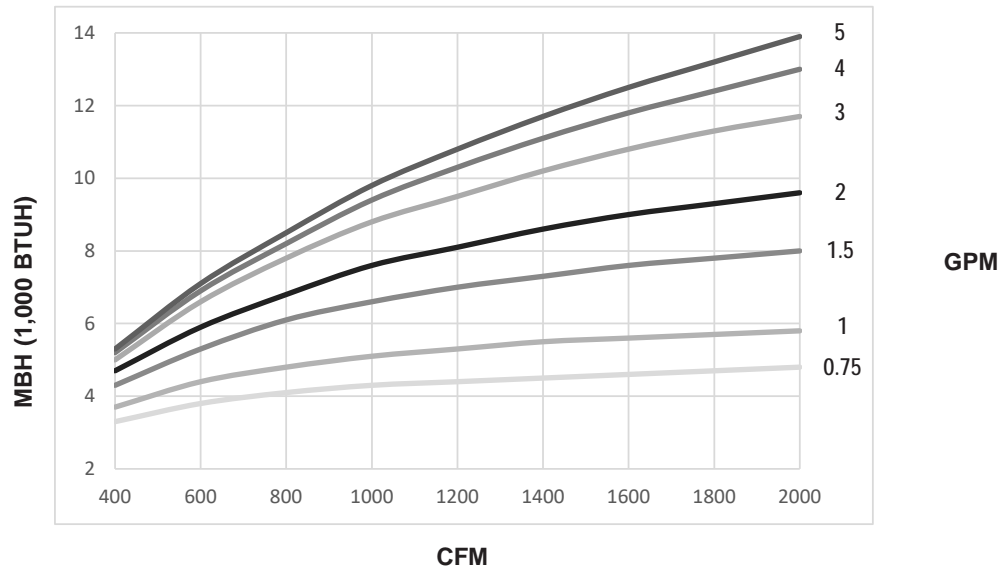

### 4 ROW - 1/2" COIL TUBES

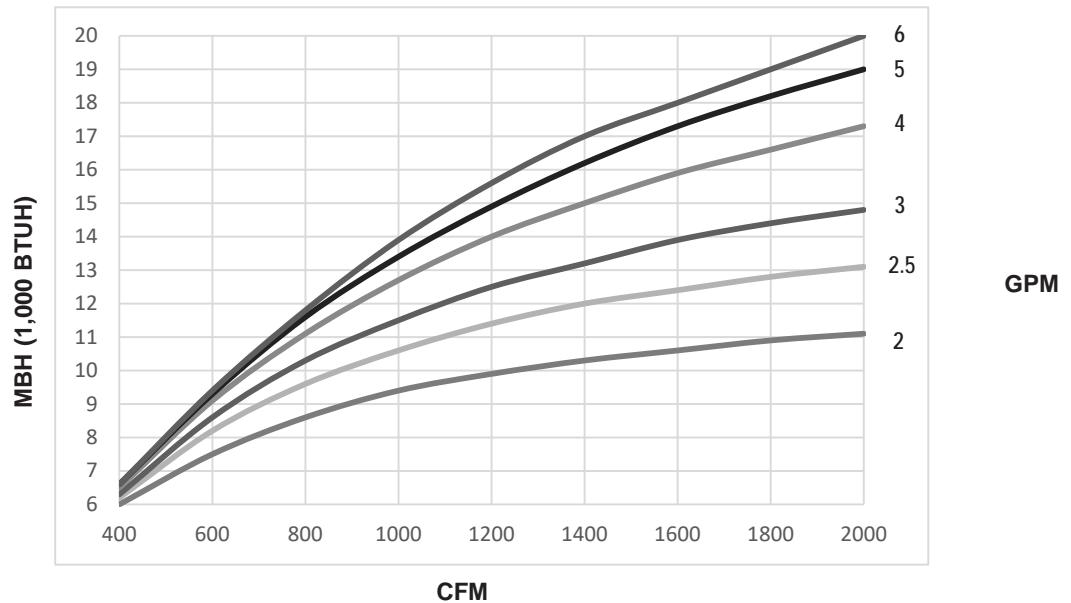

**NOTES:**

1. Data is based on 57°F entering water and 75°F entering air temperature at sea level. Entering wet bulb must be lower than entering water temperature for sensible cooling-only applications.
2. Coils have 0.50" tubes and 12 fins per inch. Alternate tube size, fin density, and circuiting options are available in Web-Select.

A web-based Computer Selection Program, Web-Select, is available to facilitate the selection process. Contact your representative to obtain access to this powerful and time-saving program.

# SENSIBLE COOLING COIL DATA

## MODEL CRC UNIT SIZES 0615, 0815, 1015

6 ROW - 1/2" COIL TUBES

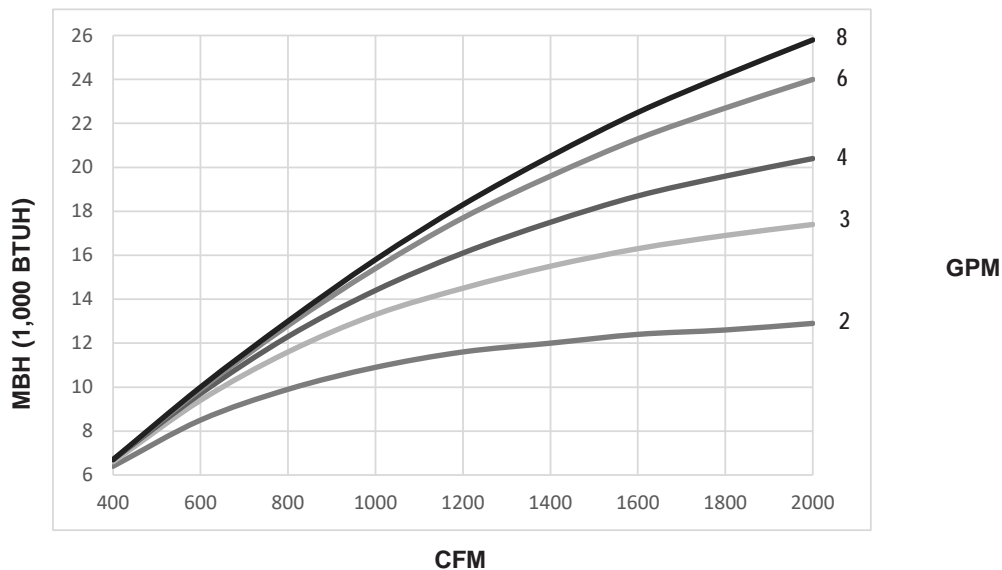

8 ROW - 1/2" COIL TUBES

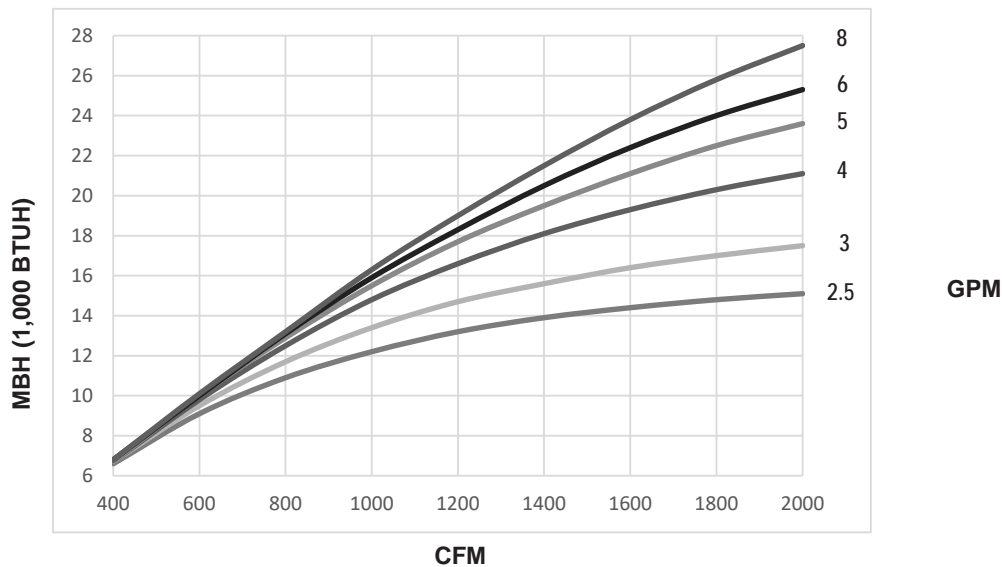

**NOTES:**

1. Data is based on 57°F entering water and 75°F entering air temperature at sea level. Entering wet bulb must be lower than entering water temperature for sensible cooling-only applications.
2. Coils have 0.50" tubes and 12 fins per inch. Alternate tube size, fin density, and circuiting options are available in Web-Select.

A web-based Computer Selection Program, Web-Select, is available to facilitate the selection process. Contact your representative to obtain access to this powerful and time-saving program.

# SENSIBLE COOLING COIL DATA

## MODEL CRC UNIT SIZES 0620, 0820, 1020

### 2 ROW - 1/2" COIL TUBES

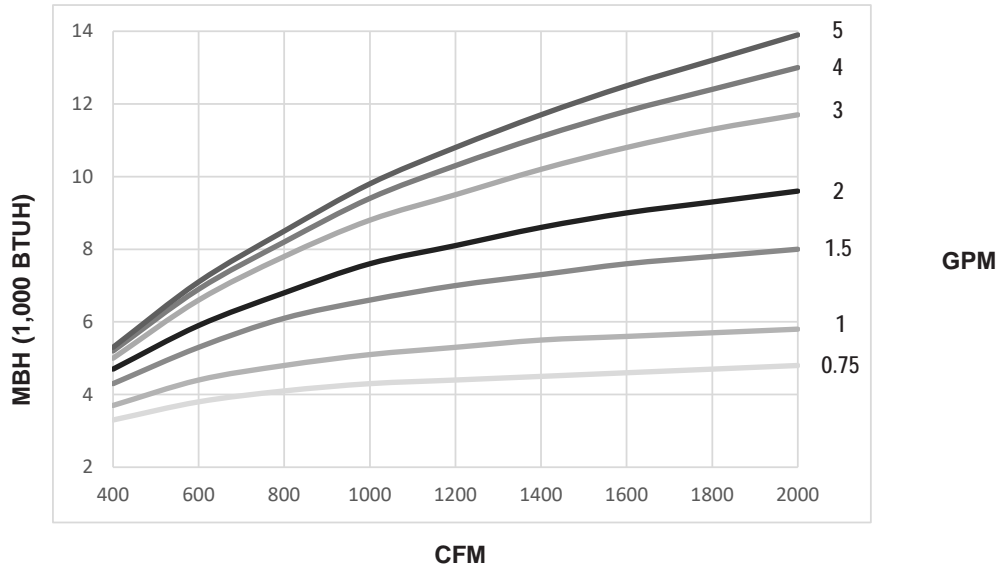

### 4 ROW - 1/2" COIL TUBES

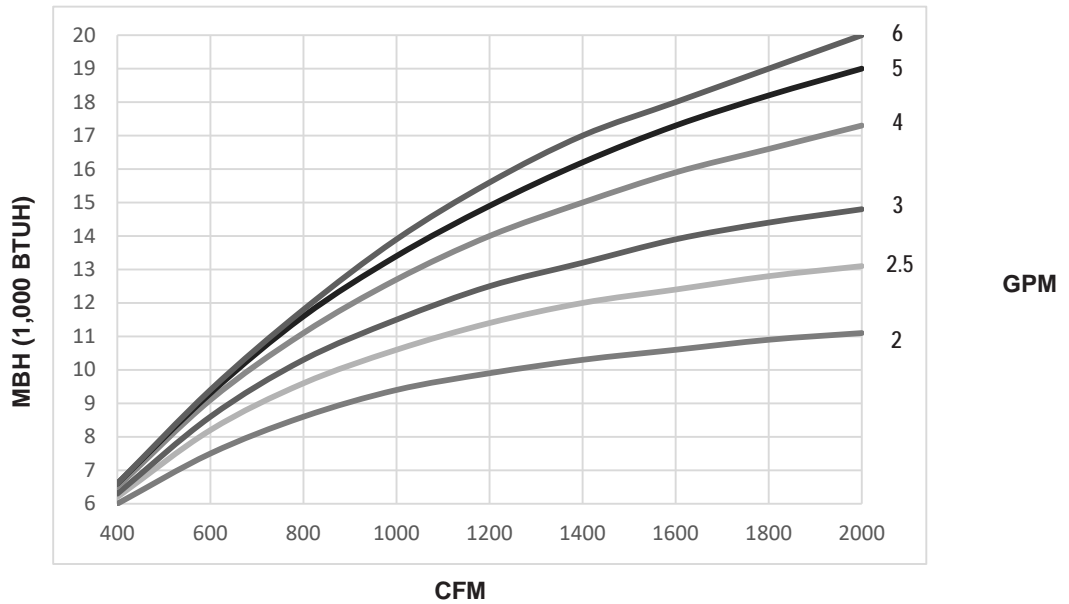

**NOTES:**

1. Data is based on 57°F entering water and 75°F entering air temperature at sea level. Entering wet bulb must be lower than entering water temperature for sensible cooling-only applications.
2. Coils have 0.50" tubes and 12 fins per inch. Alternate tube size, fin density, and circuiting options are available in Web-Select.

A web-based Computer Selection Program, Web-Select, is available to facilitate the selection process. Contact your representative to obtain access to this powerful and time-saving program.

# SENSIBLE COOLING COIL DATA

## MODEL CRC UNIT SIZES 0620, 0820, 1020

6 ROW - 1/2" COIL TUBES

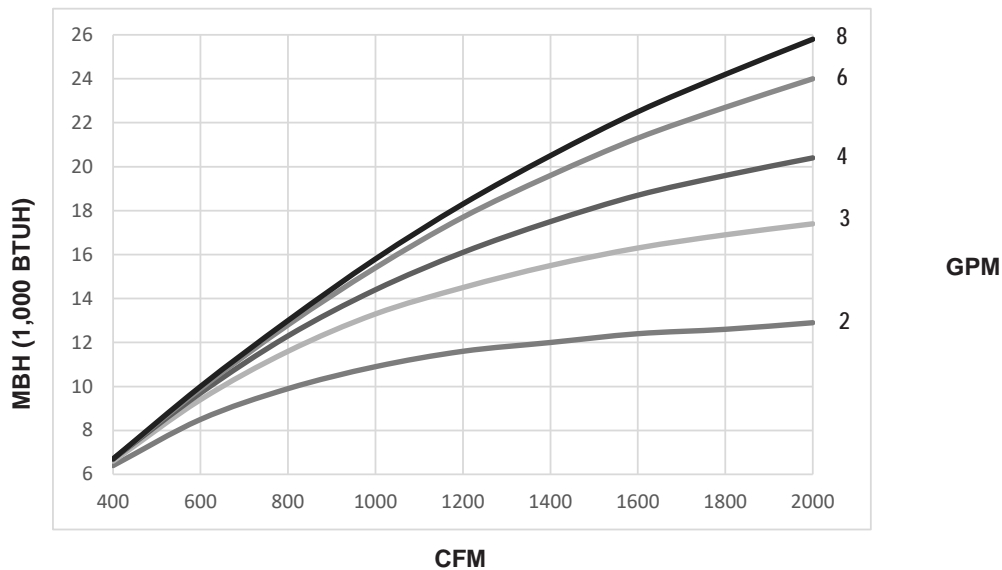

8 ROW - 1/2" COIL TUBES

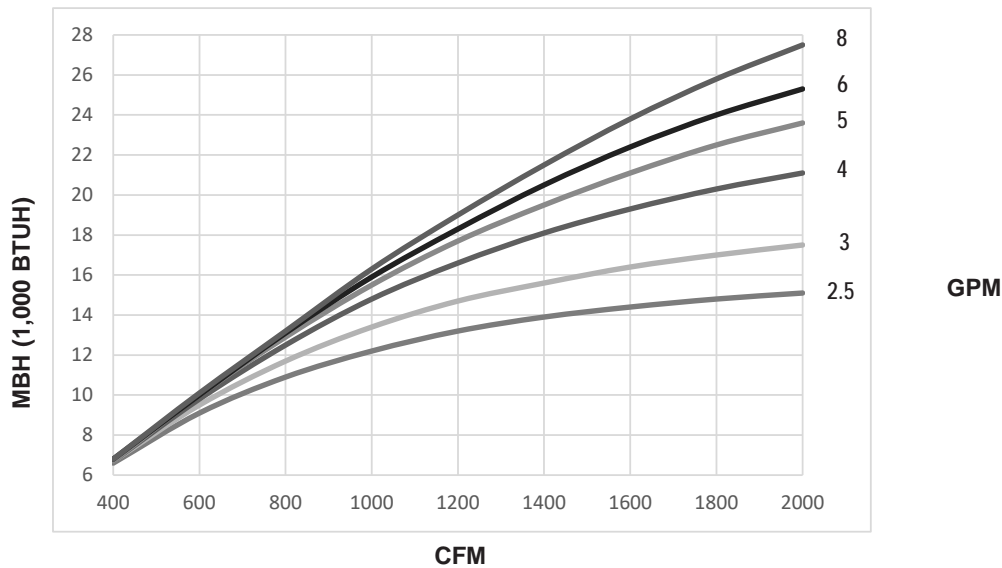

**NOTES:**

1. Data is based on 57°F entering water and 75°F entering air temperature at sea level. Entering wet bulb must be lower than entering water temperature for sensible cooling-only applications.
2. Coils have 0.50" tubes and 12 fins per inch. Alternate tube size, fin density, and circuiting options are available in Web-Select.

A web-based Computer Selection Program, Web-Select, is available to facilitate the selection process. Contact your representative to obtain access to this powerful and time-saving program.

# SENSIBLE COOLING COIL DATA

## MODEL CRC UNIT SIZES 0625, 0825, 1025

2 ROW - 1/2" COIL TUBES

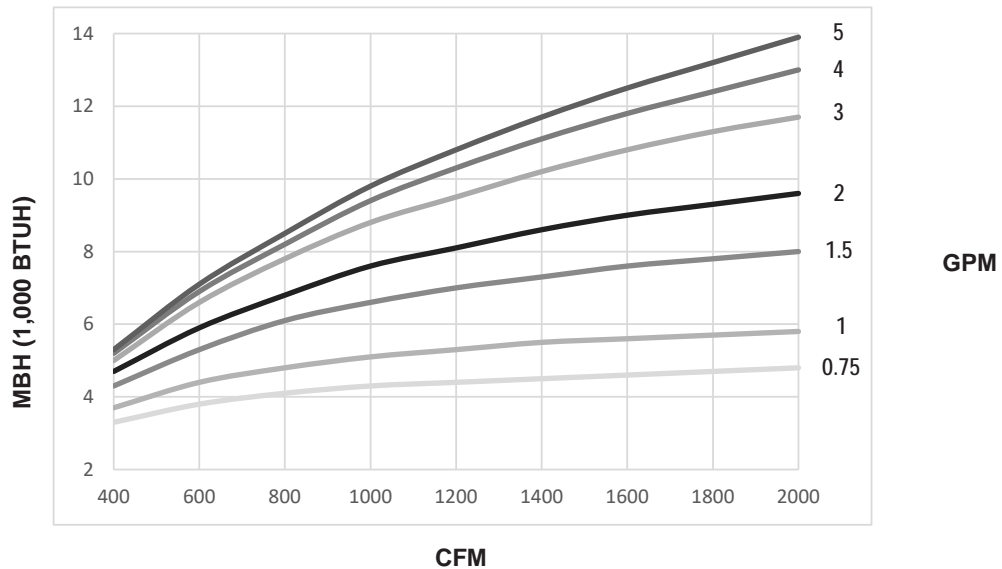

4 ROW - 1/2" COIL TUBES

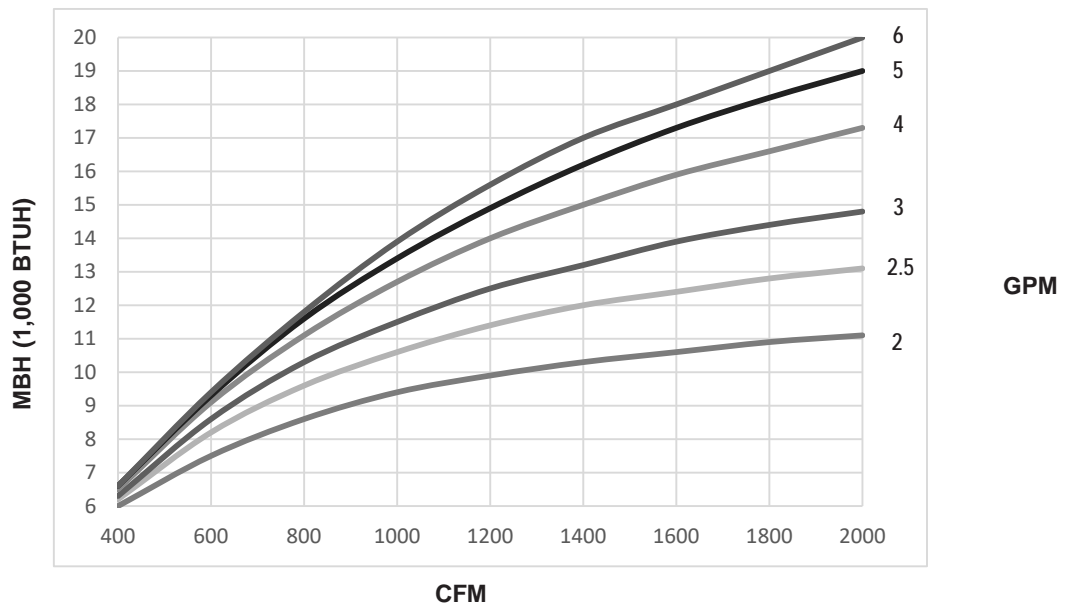

**NOTES:**

1. Data is based on 57°F entering water and 75°F entering air temperature at sea level. Entering wet bulb must be lower than entering water temperature for sensible cooling-only applications.
2. Coils have 0.50" tubes and 12 fins per inch. Alternate tube size, fin density, and circuiting options are available in Web-Select.

A web-based Computer Selection Program, Web-Select, is available to facilitate the selection process. Contact your representative to obtain access to this powerful and time-saving program.

# SENSIBLE COOLING COIL DATA

## MODEL CRC UNIT SIZES 0625, 0825, 1025

6 ROW - 1/2" COIL TUBES

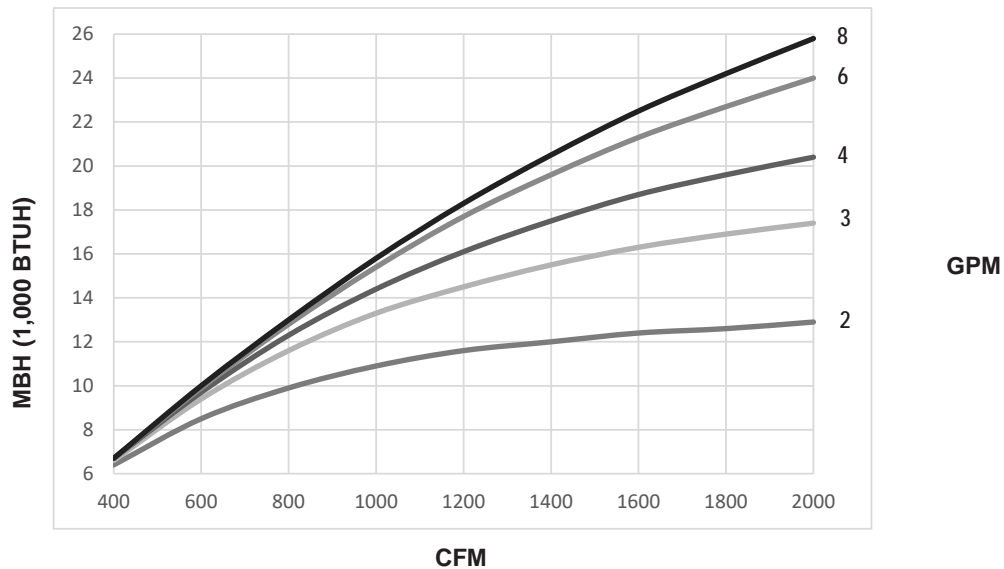

8 ROW - 1/2" COIL TUBES

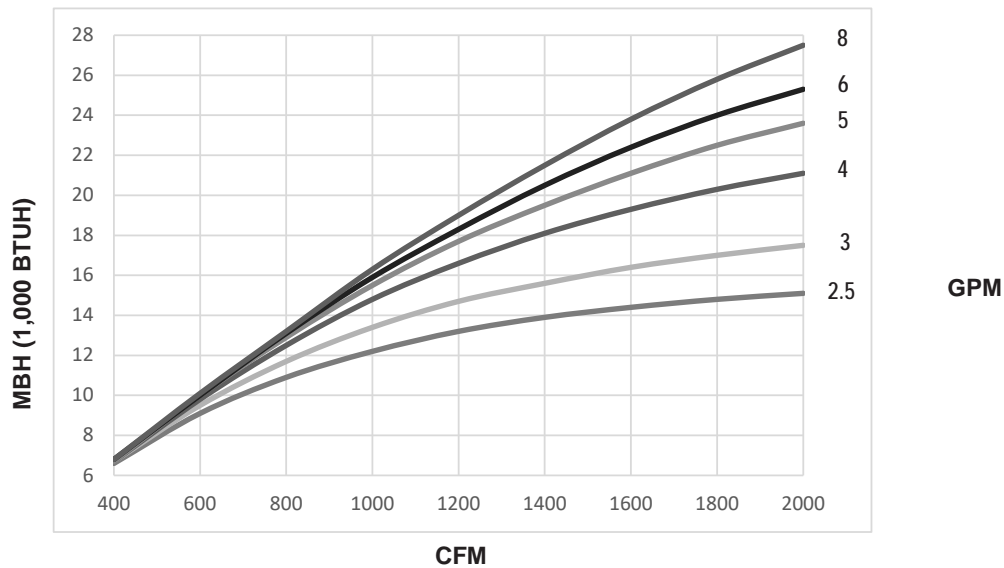

**NOTES:**

1. Data is based on 57°F entering water and 75°F entering air temperature at sea level. Entering wet bulb must be lower than entering water temperature for sensible cooling-only applications.
2. Coils have 0.50" tubes and 12 fins per inch. Alternate tube size, fin density, and circuiting options are available in Web-Select.

A web-based Computer Selection Program, Web-Select, is available to facilitate the selection process. Contact your representative to obtain access to this powerful and time-saving program.



## HOT WATER COIL DATA

### MODEL CRC-WC

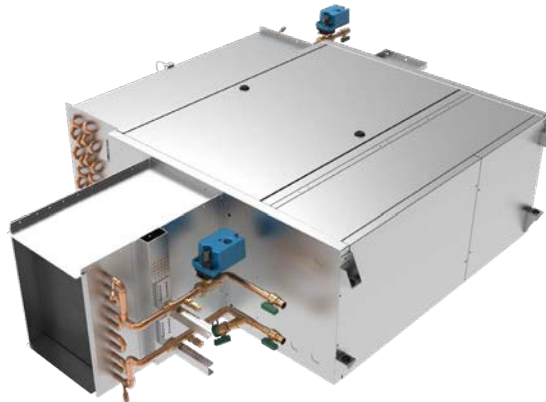

#### STANDARD FEATURES

- Coils are designed, manufactured, and tested by ENVIRO-TEC
- Aluminum fin construction with die-formed spacer collars for uniform spacing
- Mechanically expanded copper tubes, leak tested to 450 PSIG air pressure and rated at 450 PSIG working pressure at 200°F
- 1, 2, 3 and 4 row configurations
- Male sweat type water connections
- Coil access is through bottom coil casing panel for all unit sizes.

#### OPTIONAL FEATURES

- Multi-circuit coils for reduced water pressure drop
- Opposite hand water connections

#### DEFINITION OF TERMS

<b>EAT</b>	Entering Air Temperature (°F)
<b>LAT</b>	Leaving Air Temperature (°F)
<b>EWT</b>	Entering Water Temperature (°F)
<b>LWT</b>	Leaving Water Temperature (°F)
<b>CFM</b>	Air Capacity (Cubic Feet per Minute)
<b>GPM</b>	Water Capacity (Gallons per Minute)
<b>MBH</b>	1,000 BTUH
<b>BTUH</b>	Coil Heating Capacity (British Thermal Units per Hour)
<b>ΔT</b>	EWT minus EAT

#### SELECTION PROCEDURE

Hot Water Coil Performance Tables are based upon a temperature difference of 115°F between entering water and entering air. If this ΔT is suitable, proceed directly to the performance graphs for selection. For specific data points based on unit size and coil rows, please use the web-select selection tool. Web-select allows the user to choose a coil based on specific requirements, and outputs tabulated data which can be used in submittal or engineering presentations.

ENTERING WATER - AIR TEMPERATURE DIFFERENTIAL (ΔT) CORRECTION FACTORS															
ΔT	10	15	20	25	30	35	40	45	50	55	60	65	70	75	80
FACTOR	0.15	0.19	0.23	0.27	0.31	0.35	0.39	0.43	0.47	0.51	0.55	0.59	0.63	0.67	0.71
ΔT	85	90	95	100	105	110	115	120	125	130	135	140	145	150	155
FACTOR	0.75	0.79	0.83	0.88	0.92	0.96	1.00	1.04	1.08	1.13	1.17	1.21	1.25	1.29	1.33

The table above gives correction factors for various entering ΔT's (difference between entering water and entering air temperatures). Multiply MBH values obtained from selection tables by the appropriate correction factor above to obtain the actual MBH value. Air and water pressure drop can be read directly from the selection table. The leaving air and leaving water temperatures can be calculated from the following fundamental formulas:

$$LAT = EAT + \frac{BTUH}{1.085 \times CFM}$$

$$LWT = EWT - \frac{BTUH}{500 \times GPM}$$

A web-based Computer Selection Program, Web-Select, is available to facilitate the selection process. Contact your representative to obtain access to this powerful and time-saving program.

# HOT WATER COIL DATA

## MODEL CRC-WC UNIT SIZES 0407, 0507, 0607

1 ROW, 1 CIRCUIT - 1/2" COIL TUBES

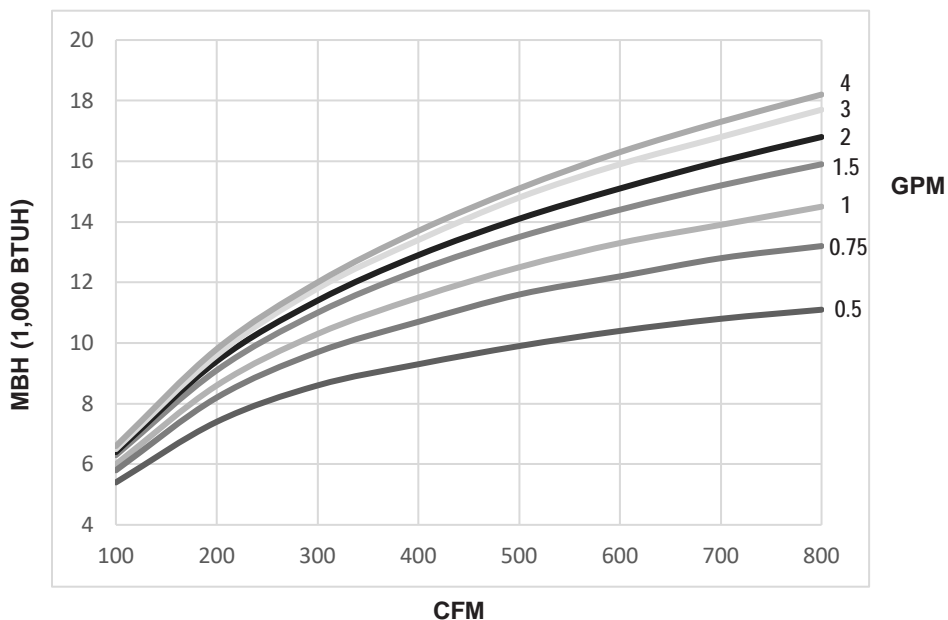

2 ROW, 2 CIRCUIT - 1/2" COIL TUBES

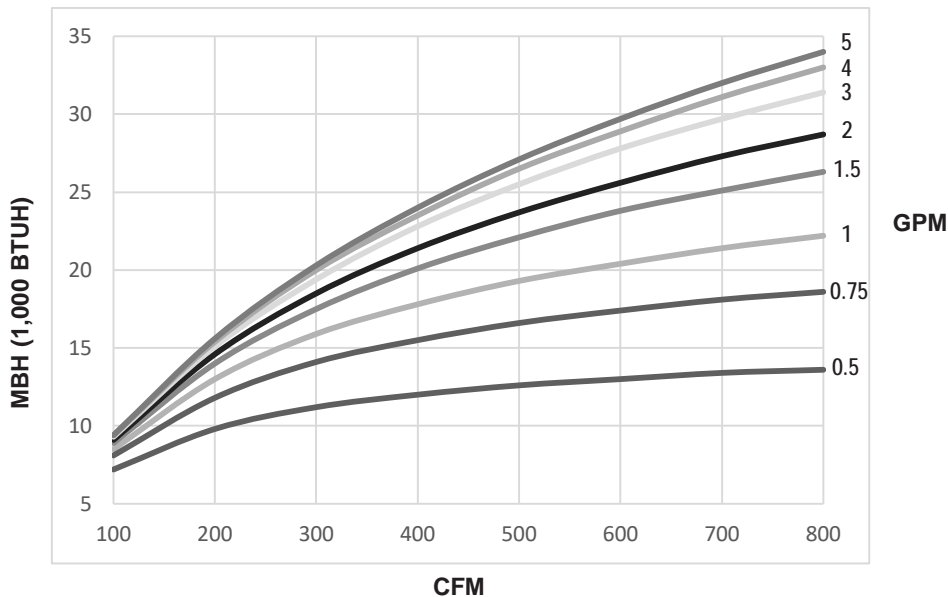

**NOTES:**

1. Data is based on 180°F entering water and 65°F entering air temperature at sea level. See selection procedure for other conditions.
2. For optimum diffuser performance in overhead heating applications, the supply air temperature should be within 20°F of the desired space temperature. This typically requires a higher air capacity which provides higher air motion in the space, increasing thermal comfort. The hot water coil should be selected with this in mind, keeping the LAT as low as possible.

A web-based Computer Selection Program, Web-Select, is available to facilitate the selection process. Contact your representative to obtain access to this powerful and time-saving program.

# HOT WATER COIL DATA

## MODEL CRC-WC UNIT SIZES 0410, 0510, 0610

### 1 ROW, 1 CIRCUIT - 1/2" COIL TUBES

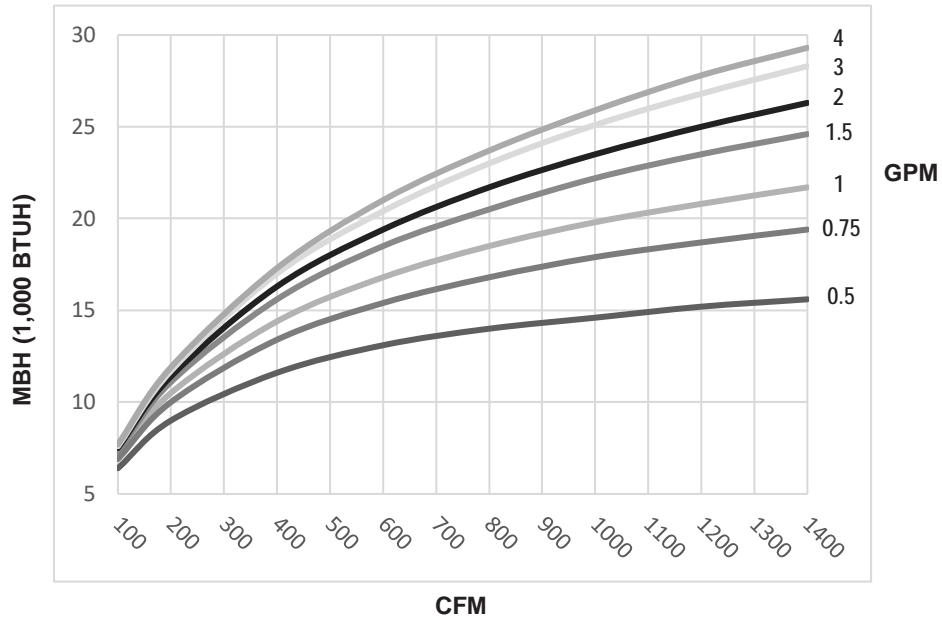

### 2 ROW, 2 CIRCUIT - 1/2" COIL TUBES

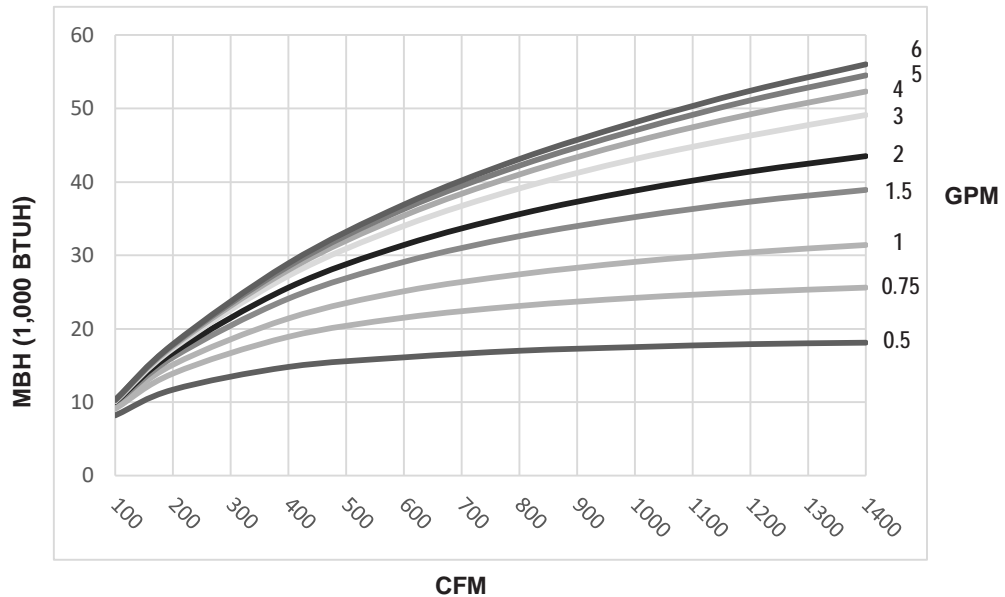

**NOTES:**

1. Data is based on 180°F entering water and 65°F entering air temperature at sea level. See selection procedure for other conditions.
2. For optimum diffuser performance in overhead heating applications, the supply air temperature should be within 20°F of the desired space temperature. This typically requires a higher air capacity which provides higher air motion in the space, increasing thermal comfort. The hot water coil should be selected with this in mind, keeping the LAT as low as possible.

A web-based Computer Selection Program, Web-Select, is available to facilitate the selection process. Contact your representative to obtain access to this powerful and time-saving program.

# HOT WATER COIL DATA

## MODEL CRC-WC UNIT SIZES 0412, 0512, 0612, 0812

1 ROW, 1 CIRCUIT - 1/2" COIL TUBES

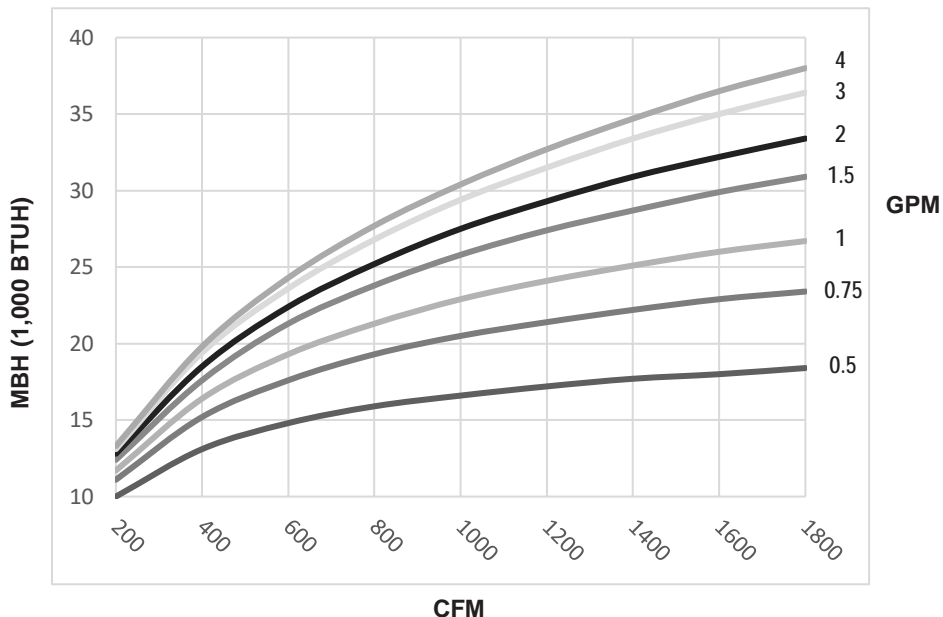

2 ROW, 2 CIRCUIT - 1/2" COIL TUBES

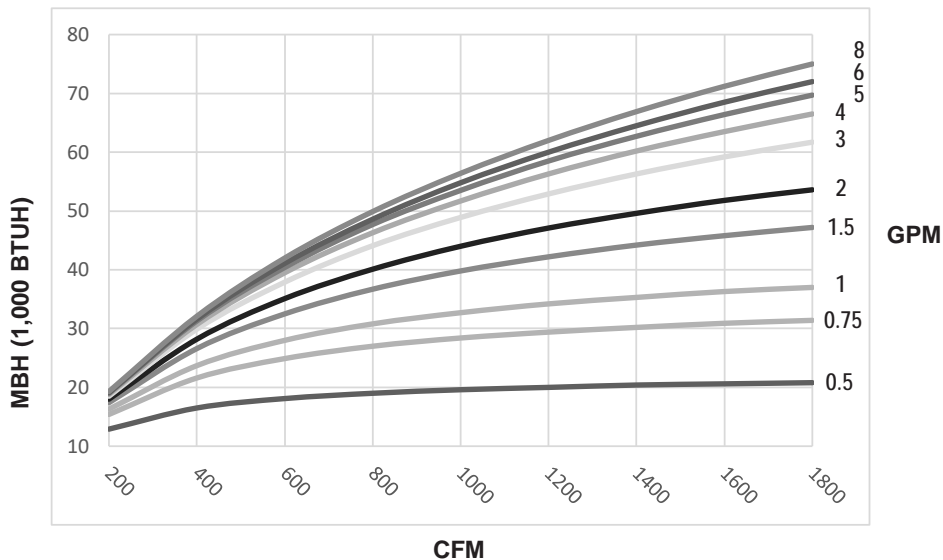

**NOTES:**

1. Data is based on 180°F entering water and 65°F entering air temperature at sea level. See selection procedure for other conditions.
2. For optimum diffuser performance in overhead heating applications, the supply air temperature should be within 20°F of the desired space temperature. This typically requires a higher air capacity which provides higher air motion in the space, increasing thermal comfort. The hot water coil should be selected with this in mind, keeping the LAT as low as possible.

A web-based Computer Selection Program, Web-Select, is available to facilitate the selection process. Contact your representative to obtain access to this powerful and time-saving program.

# HOT WATER COIL DATA

## MODEL CRC-WC UNIT SIZES 0615, 0815, 1015

### 1 ROW, 1 CIRCUIT - 1/2" COIL TUBES

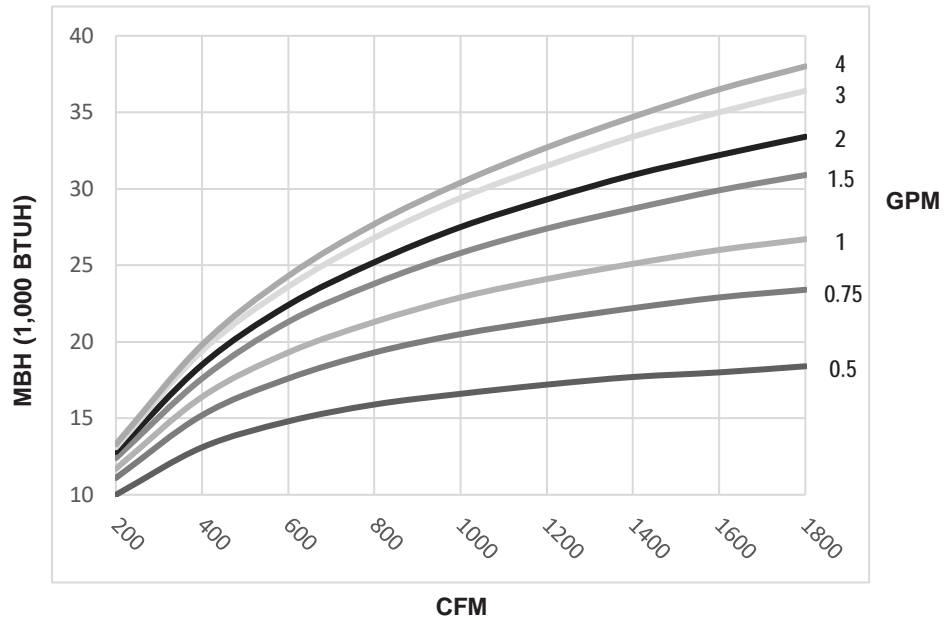

### 2 ROW, 2 CIRCUIT - 1/2" COIL TUBES

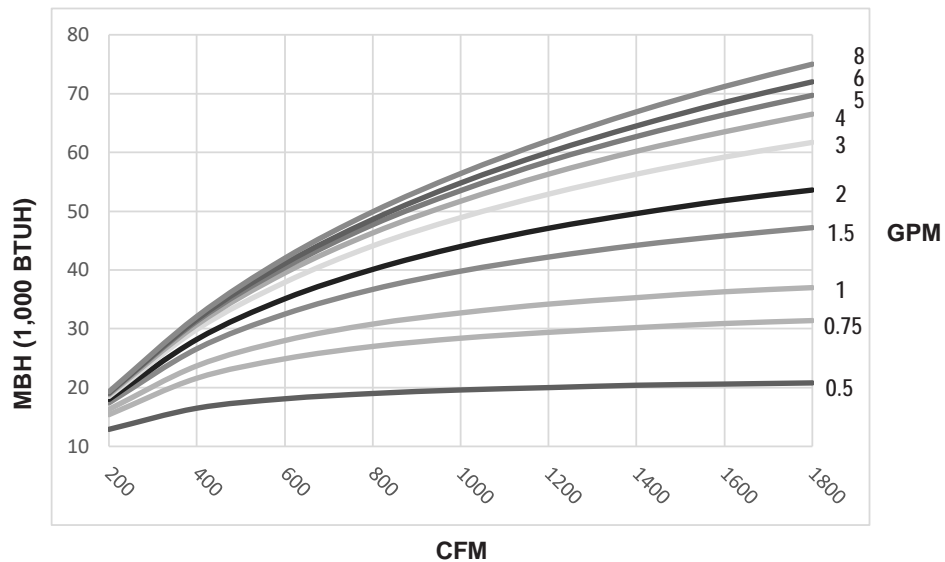

**NOTES:**

1. Data is based on 180°F entering water and 65°F entering air temperature at sea level. See selection procedure for other conditions.
2. For optimum diffuser performance in overhead heating applications, the supply air temperature should be within 20°F of the desired space temperature. This typically requires a higher air capacity which provides higher air motion in the space, increasing thermal comfort. The hot water coil should be selected with this in mind, keeping the LAT as low as possible.

A web-based Computer Selection Program, Web-Select, is available to facilitate the selection process. Contact your representative to obtain access to this powerful and time-saving program.

# HOT WATER COIL DATA

## MODEL CRC-WC UNIT SIZES 0620, 0820, 1020

1 ROW, 3 CIRCUIT - 1/2" COIL TUBES

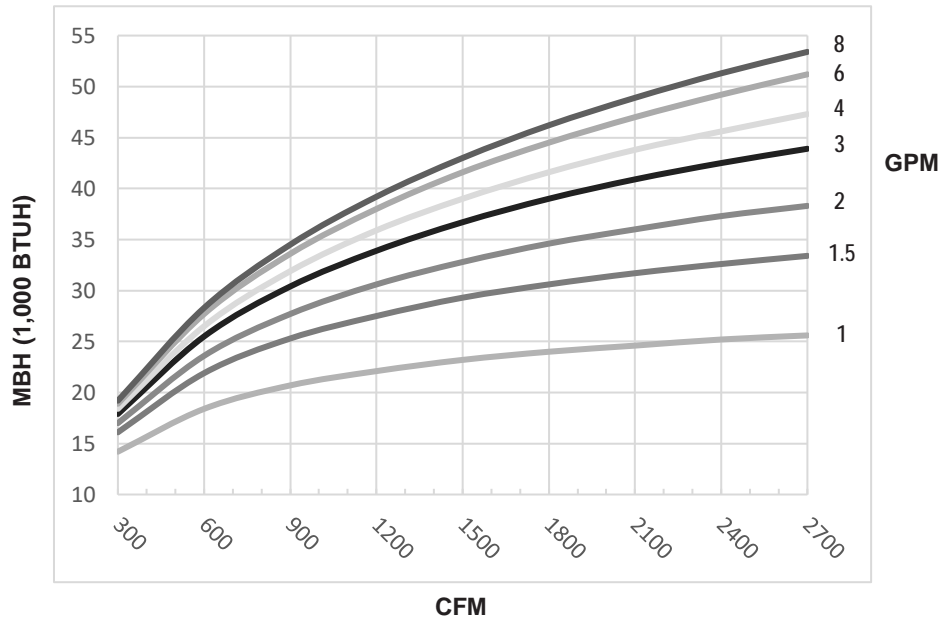

2 ROW, 6 CIRCUIT - 1/2" COIL TUBES

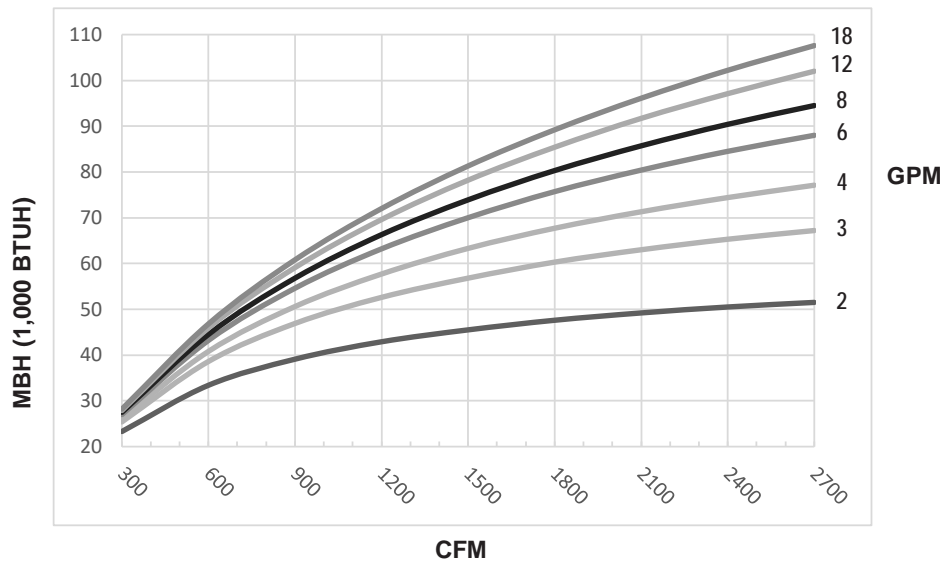

**NOTES:**

1. Data is based on 180°F entering water and 65°F entering air temperature at sea level. See selection procedure for other conditions.
2. For optimum diffuser performance in overhead heating applications, the supply air temperature should be within 20°F of the desired space temperature. This typically requires a higher air capacity which provides higher air motion in the space, increasing thermal comfort. The hot water coil should be selected with this in mind, keeping the LAT as low as possible.

A web-based Computer Selection Program, Web-Select, is available to facilitate the selection process. Contact your representative to obtain access to this powerful and time-saving program.

# HOT WATER COIL DATA

## MODEL CRC-WC UNIT SIZES 0625, 0825, 1025

### 1 ROW, 3 CIRCUIT - 1/2" COIL TUBES

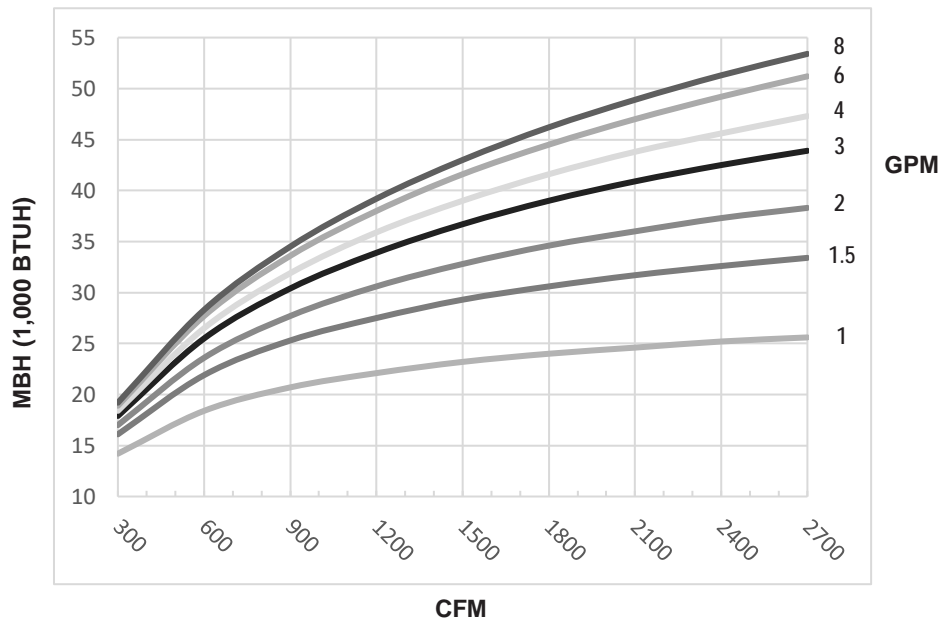

### 2 ROW, 6 CIRCUIT - 1/2" COIL TUBES

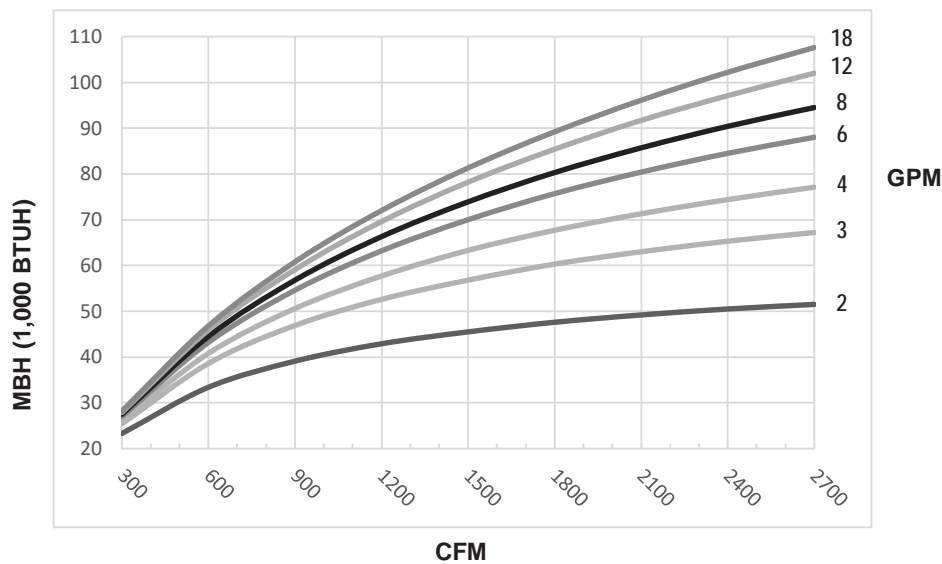

**NOTES:**

1. Data is based on 180°F entering water and 65°F entering air temperature at sea level. See selection procedure for other conditions.
2. For optimum diffuser performance in overhead heating applications, the supply air temperature should be within 20°F of the desired space temperature. This typically requires a higher air capacity which provides higher air motion in the space, increasing thermal comfort. The hot water coil should be selected with this in mind, keeping the LAT as low as possible.

A web-based Computer Selection Program, Web-Select, is available to facilitate the selection process. Contact your representative to obtain access to this powerful and time-saving program.

## COIL FACE AREA, FREE AREA, AND FILTER SIZES

---

### THROWAWAY / PLEATED 1" AND 2" FILTERS

UNIT SIZE	HEATING COIL FACE AREA	COOLING COIL FACE AREA	NOMINAL FILTER SIZES	1" THROWAWAY FACE AREA	2" THROWAWAY FACE AREA	1" PLEATED GROSS MEDIA AREA	2" PLEATED GROSS MEDIA AREA
07	0.83 [0.08]	2.69 [0.25]	(1) 10.5 x 31 [267 x 787]	2.12 [0.2]	2.12 [0.2]	3.7 [0.34]	6.4 [0.59]
10	1.33 [0.12]	2.69 [0.25]	(1) 10.5 x 31 [267 x 787]	2.12 [0.2]	2.12 [0.2]	3.7 [0.34]	6.4 [0.59]
12	2 [0.19]	3.75 [0.35]	(1) 13.25 x 35.75 [337 x 908]	3.12 [0.29]	3.12 [0.29]	5.5 [0.51]	9.4 [0.87]
15	2 [0.19]	3.75 [0.35]	(1) 13.25 x 35.75 [337 x 908]	3.12 [0.29]	3.12 [0.29]	5.5 [0.51]	9.4 [0.87]
20	2.67 [0.25]	3.75 [0.35]	(1) 13.25 x 35.75 [337 x 908]	3.12 [0.29]	3.12 [0.29]	5.5 [0.51]	9.4 [0.87]
25	2.67 [0.25]	3.75 [0.35]	(1) 13.25 x 35.75 [337 x 908]	3.12 [0.29]	3.12 [0.29]	5.5 [0.51]	9.4 [0.87]

#### NOTES:

1. All filters are an optional feature. For optimal unit performance, filter type should be selected during the unit selection and ordering process.
2. Filter sizes are nominal, measured in inches [millimeters]
3. Coil and filter face areas are measured in square feet [square meters]



## GUIDE SPECIFICATIONS

---

### GENERAL

Furnish and install ENVIRO-TEC Model CRC, or equal, Series Flow Fan Powered Sensible Cooling Terminals of the sizes and capacities scheduled. Units shall be ETL listed. Terminals with electric heat shall be listed as an assembly. Separate listings for the terminal and electric heater are not acceptable. Terminals shall include a single point electrical connection.

The entire unit shall be designed and built as a single unit. Field-assembled components or built-up terminals employing components from multiple manufacturers are not acceptable.

### CONSTRUCTION

Terminals shall be constructed of not less than 20 gauge galvanized steel, able to with-stand a 125 hour salt spray test per ASTM B-117. The terminal casing shall be mechanically assembled (spot-welded casings are not acceptable).

Casing shall be internally lined with 1/2" thick dual density fiberglass insulation, rated for a maximum air velocity of 5000 f.p.m. Maximum thermal conductivity shall be 0.24 (BTU • in) / (hr • ft<sup>2</sup> • °F). Insulation must meet all requirements of ASTM C1071 (including C665), UL 181 for erosion, and carry a 25/50 rating for flame spread/smoke developed per ASTM E-84, UL 723 and NFPA 90A. Raw insulation edges on the discharge of the unit must be covered with metal liner to eliminate flaking of insulation during field duct connections. Simple "buttering" of raw edges with an approved sealant is not acceptable.

Casing shall have full top and bottom access to gain access to the primary air valve and fan assembly. The opening shall be sufficiently large to allow complete removal of the fan if necessary. The casing shall be constructed in a manner to provide a single rectangular discharge collar. Multiple discharge openings are not acceptable. All appurtenances including control assemblies, control enclosures, sensible cooling coils, hot water heating coils, and electric heating coils shall not extend beyond the top or bottom of the unit casing.

### SOUND

The terminal manufacturer shall provide AHRI certified sound power data for radiated and discharge sound. The sound levels shall not exceed the octave band sound power levels indicated on the schedule. If the sound data does not meet scheduled criteria, the con-

tractor shall be responsible for the provision and installation of any additional equipment or material necessary to achieve the scheduled sound performance.

### PRIMARY AIR VALVE

The primary air valve shall consist of a minimum 20 gauge cylindrical body that includes embossment rings for rigidity. The damper blade shall be connected to a solid shaft by means of an integral molded sleeve which does not require screw or bolt fasteners. The shaft shall be manufactured of a low thermal conducting composite material, and include a molded damper position indicator visible from the exterior of the unit. The damper shall pivot in nylon bearings. The damper actuator shall be mounted on the exterior of the terminal for ease of service. The valve assembly shall include internal mechanical stops for both full open and closed positions. The damper blade seal shall be secured without use of adhesives. The air valve leakage shall not exceed 1% of maximum inlet rated airflow at 3" W.G. inlet pressure.

### PRIMARY AIRFLOW SENSOR

For inlet diameters 6" or greater, the differential pressure airflow sensor shall traverse the duct along two perpendicular diameters. Cylindrically shaped inlets shall utilize the equal cross sectional area or log-linear traverse method. Single axis sensor shall not be acceptable for duct diameters 6" or larger. A minimum of 12 total pressure sensing points shall be utilized. The total pressure inputs shall be averaged using a pressure chamber located at the center of the sensor. A sensor that delivers the differential pressure signal from one end of the sensor is not acceptable. The sensor shall output an amplified differential pressure signal that is at least 2.3 times the equivalent velocity pressure signal obtained from a conventional pitot tube. The sensor shall develop a differential pressure of 0.015" w.g. at an air velocity of < 325 FPM. Documentation shall be submitted which substantiates this requirement. Balancing taps and airflow calibration charts shall be provided for field airflow measurements.

### MOTOR AND FAN ASSEMBLY

The unit fan shall utilize a forward curved, dynamically balanced, galvanized wheel with a direct drive motor. Fan motor shall be Electronically Commutated Motor (ECM) motor type. Motor shall be brushless DC controlled by an integral controller / inverter that operates the wound stator and senses rotor position to elec-

## GUIDE SPECIFICATIONS

---

tronically commutate the stator. Motor shall be permanent magnet type with near-zero rotor losses designed for synchronous rotation. The motor shall utilize permanently lubricated ball bearings. Motor shall maintain minimum 70% efficiency over the entire operating range. Motor speed control shall be accomplished through a PWM (pulse width modulation) controller specifically designed for compatibility with the ECM. The speed controller shall have terminals for field verification of fan capacity utilizing a digital volt meter. A calibration graph shall be supplied indicating Fan CFM verses DC Volts.

### SENSIBLE COOLING COIL

Terminal shall include an integral sensible cooling coil where indicated on the plans. The coil shall be manufactured by the terminal unit manufacturer and shall have a minimum 20 gauge galvanized sheet metal casing. Coil to be constructed of pure aluminum fins with full fin collars to assure accurate fin spacing and maximum tube contact. Fins shall be spaced with a minimum of 10 per inch and mechanically fixed to seamless copper tubes for maximum heat transfer.

Each coil shall be hydrostatically tested at a minimum of 450 PSIG under water, and rated for a maximum 450 PSIG working pressure at 200°F.

### HOT WATER COIL

Terminal shall include an integral hot water coil where indicated on the plans. The coil shall be manufactured by the terminal unit manufacturer and shall have a minimum 20 gauge galvanized sheet metal casing. Coil to be constructed of pure aluminum fins with full fin collars to assure accurate fin spacing and maximum tube contact. Fins shall be spaced with a minimum of 10 per inch and mechanically fixed to seamless copper tubes for maximum heat transfer.

Each coil shall be hydrostatically tested at a minimum of 450 PSIG under water, and rated for a maximum 450 PSIG working pressure at 200°F. Coils shall incorporate a built in, flush mounted access plate, allowing bottom access to coil.

### ELECTRIC HEATERS

Terminal shall include an integral electric heater where indicated on the plans. The heater cabinet shall be constructed of not less than 20 gauge galvanized steel. Heater shall have a hinged access panel for entry to the controls.

A power disconnect shall be furnished to render the heater non-operational. Heater shall be furnished with all controls necessary for safe operation and full compliance with UL 1995 and National Electric Code requirements.

Heater shall have a single point electrical connection. It shall include a primary disc-type automatic reset high temperature limit, secondary high limit(s), Ni-Chrome elements, and fusing per UL and NEC. Heater shall have complete wiring diagram with label indicating power requirement and KW output. Heater shall be interlocked with fan terminal so as to preclude operation of the heater when the fan is not running.

### OPTIONS

#### Foil Faced Insulation

Insulation shall be covered with scrim backed foil facing. All insulation edges shall be covered with foil or metal nosing. Insulation shall meet ASTM C1136 and ASTM C665 for mold, mildew and humidity resistance.

#### Elastomeric Closed Cell Foam Insulation

Provide Elastomeric Closed Cell Foam Insulation in lieu of standard. Insulation shall conform to UL 181 for erosion and NFPA 90A for fire, smoke and melting, and comply with a 25/50 Flame Spread and Smoke Developed Index per ASTM E-84 or UL 723. Additionally, insulation shall comply with Antimicrobial Performance Rating of 0, no observed growth, per ASTM G-21. Polyethylene insulation is not acceptable.

#### Double Wall Construction

The terminal casing shall be 1" double wall construction using a 20 gauge galvanized metal liner covering all insulation.

#### Filters

Terminals shall include a 1" or 2" filter. Filter shall be secured with quick release clips, allowing removal without horizontal sliding.

#### Piping Packages

Provide a standard factory assembled and factory installed non-insulated valve piping package to consist of a 2-way or 3-way, on/off, motorized electric control valve, unions, and two ball isolation valves. Control valves are piped normally closed to the coil. Maximum entering water temperature on the control valve shall be 200°F. Maximum operating pressure shall be 450 PSIG.

**Option:** Provide 24VAC floating point modulating control valve (fail-in-place) in lieu of standard 2-position

## GUIDE SPECIFICATIONS

---

control valve with factory assembled valve piping package.

**Option:** Provide 0-10VDC proportional control valve (fail-in-place) in lieu of standard 2-position control valve with factory assembled valve piping package.

**Option:** Provide either a fixed or adjustable flow control device for each piping package.

**Option:** Normally Open in lieu of Normally Closed on/off valves.

**Option:** Spring return (N.O. or N.C.) modulating control valve.

**Option:** Spring return (N.O. or N.C.) proportional control valve.

**Option:** Provide y-strainers, and/or pressure-temperature ports for each piping package.

**Option:** Provide ship-loose 18" stainless steel flexible hoses.

Piping package shall be completely factory assembled, including interconnecting pipe, and shipped factory-installed to the coil and unit.

### CONTROLS

#### **DDC for BACnet**

Each VAV terminal unit shall be bundled with a digital controller. The controller shall be compatible with a MS/TP (Master-Slave/Token-Passing) BACnet system network. A unique network address and a BACnet site address shall be assigned to each controller, and referenced to the tagging system used on the drawings and in the schedules provided by the Project Engineer. All controllers shall be factory mounted and wired, with the controller's hardware address set, and all of the individual terminal's data pre-loaded into the controller. The terminal's data shall include, but not be limited to Max CFM, Min CFM, Heating CFM, and terminal K factor. Heating system operating data shall also be factory installed for all terminals with heat. Communications with the digital controller shall be accomplished through the MS/TP BACnet network or through a Bluetooth connector. The digital controller shall have hardware input and output connections to facilitate the specified sequence of operation in either the network mode, or on a stand-alone basis. The terminal unit manufacturer shall coordinate, where necessary, with the Temperature Control Contractor.

ENVIRO-TEC is a registered trademark and FlowStar™ is a trademark of Johnson Controls in the United States of America and other countries. Other trademarks used herein may be trademarks or registered trademarks of other companies.

Catalog: ET130.13-EG12 (0921) New Release  
© 2021 Johnson Controls P.O. Box 423, Milwaukee, WI 53201  
[www.enviro-tec.com](http://www.enviro-tec.com)

